

| 3DUDPHWHU   | 6\PERO                | /LPLW | 8QLW |
|---|-----------------------|-------|------|
| 'UDLQ VRXUFH 9ROWDJH                                    | 9 <sub>6</sub>        |       | 9    |
| *DWH VRXUFH 9ROWDJH                                     | ' <sub>6</sub>        | 9 f   | 9    |
| 'UDLQ &XUUHQW   | '                     | ,     | P\$  |
| 3XOVHG 'UDLQ &XUUHQW                                    | ' <sub>0</sub>        |       | \$   |
| 7RWDO 3RZHU 'LVVLSDWLRQ # 7                             | 3                     |       | P:   |
| 7KHUPDO 5HVLWLROFWRXPPELHQW%# 6WHDG\ 6WDWH <sub>5</sub> | G\ 6WDWH <sub>5</sub> |       | 5 :  |
| -XQFWLRQ DQG 6WRUDJH 7HPSHUDWXUH 5DQJH . 77             | DQJH . 77             | 7     |      |

v 2 UGHULQJ , QIRUPPSVLRQ

| 35() (5(' 3 1 | 3\$&.,1* &2'(' | 0DUNLQJ | 0,1,080 3\$&.\$*( SF | ,11(5 %2; 48\$17,7< S | 287(5 &\$572 48\$17,7< S | '(/,9(5< 02'(' |
|---------------|----------------|---------|----------------------|-----------------------|--------------------------|----------------|
| 1 .'' :4      | )              | .'      |                      |                       |                          | 3 UHHO         |



v(OHFWULFDO & KDZDFW\HQLNWLFRWKHUZLVH QRWHG

| 3DUDPHWHU                      | 6\PERC  | &RQGLWLRQV      | 0LQ | 7\S | 0D[ | 8QLWV |
|--------------------------------|---------|-----------------|-----|-----|-----|-------|
| 6WDWLF 3DUDPHWHU               |         |                 |     |     |     |       |
| 'UDLQ 6RXUFH %UHDNGRZQ         | 9ROWDJH | ·6 9%9, \$      | 9   |     |     | 9     |
| =HUR *DWH 9ROWDJH 'UDLQ &XUHQW |         | 9·6 9 9·6 ,9 7M |     |     |     |       |

\*DWH %RG\ /HDNDJH &XUHQW·66 9·6, f 9 9 9 f \$



v 7\SLFDO 3HUIRUPDQFH &KDUDFWHULVWLFV

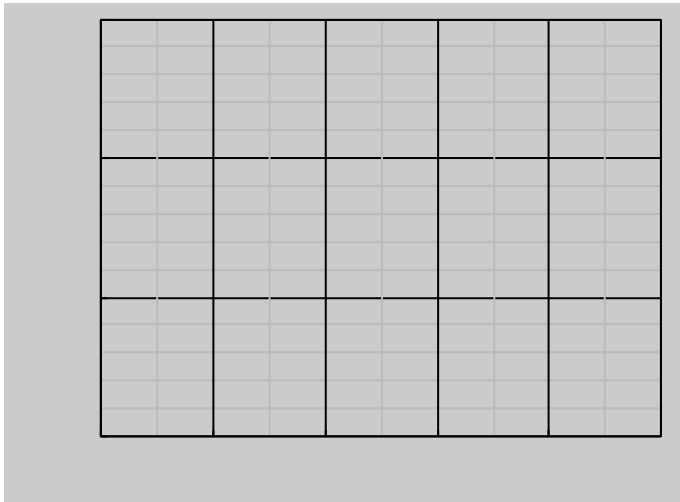

)SXXU & KDUDFWHULVWLFV

JXUH 7UDQVIHV & KDUDFWHULVWLFV

)LJXUH & DSDFLWDQFH & KDUDFWHULVWLFV

)LJXUH \*DWH & KDUDFWHULVWLFV

)LJXUH 2Q 5HVLVWVWRFH R XV FHDWRHOWDJH)LJXUHOLJRGFD 5HVLVWVWRFH

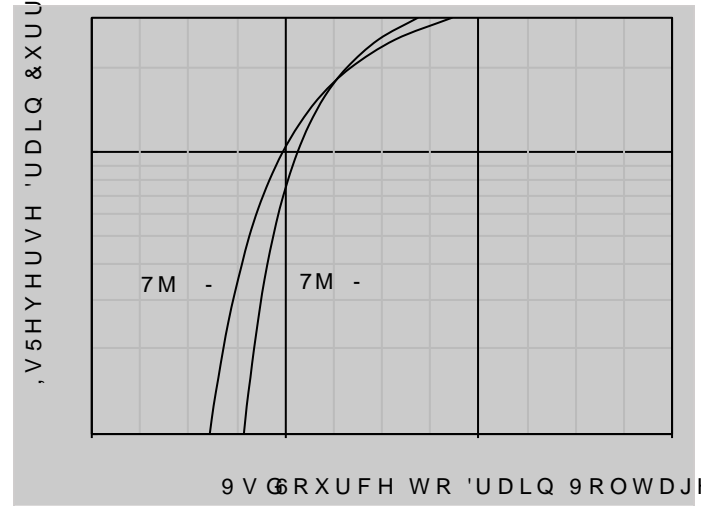
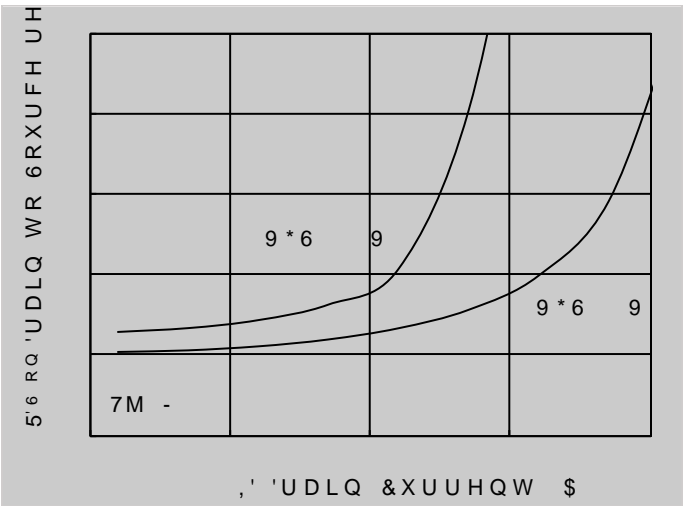

5'6) 6'6 'UDLQ & XUHHQW \$

)RUZDUG FK DLUXFMHULVWLFV

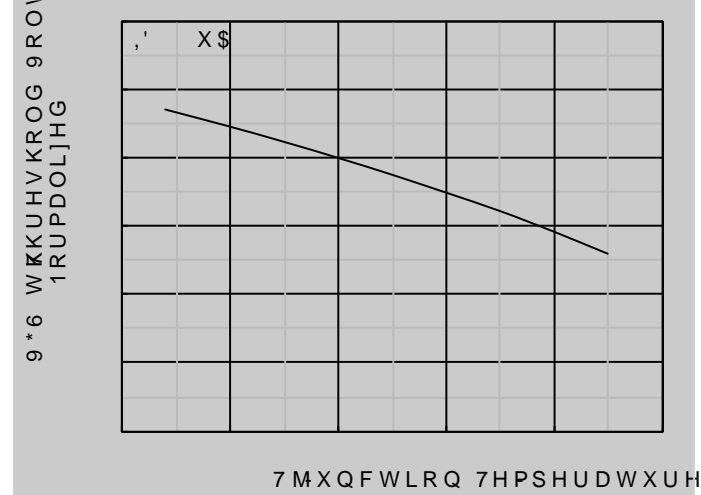
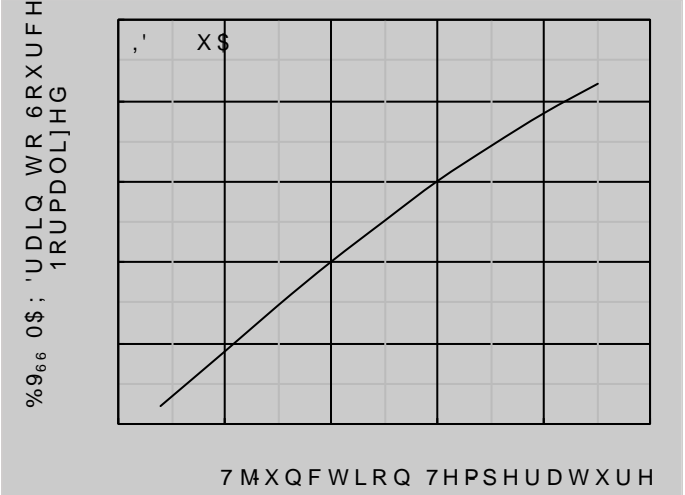

)LJXUH 1RUPDOLJHG 9ROWDJH 9

)LJXUH 1RUPDOLJHG 7KU



)LJXUH 0D[LXP7KUDQDLOH,QPS HGDQFH

)LJXUH 6DIH 2SHUDV



v 7HVW & LUFXLWV :DYHIRUPV

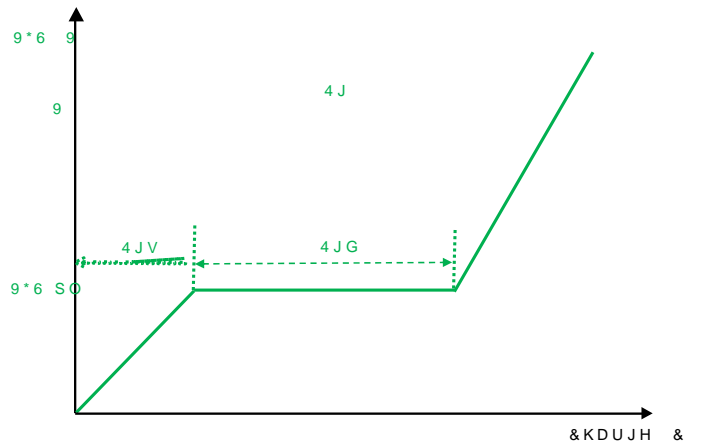
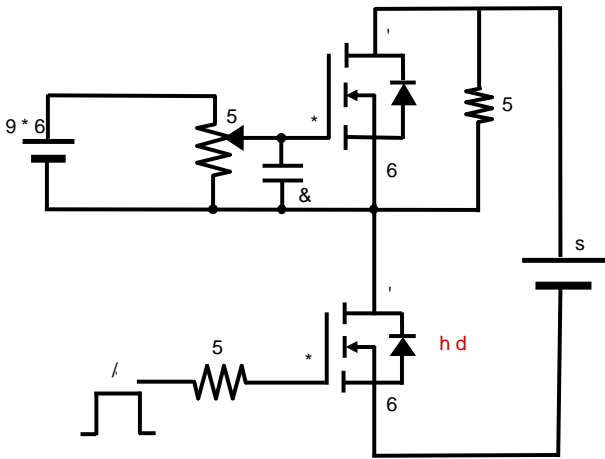

)LJXUHDWH &KDUJHUFXLW & :DYHIRUP

)LJXUHFH\LVWLYH 6Z\W\&K\Q\X\L\W\ :DYHIRUP

)LJXUHL&GH 5HFRYHU\ 7HVW &LUFXLW :DYHIRUP



v 6 2 7 3 D F N D J H 2 X W O L Q H ' L P H Q V L R Q V

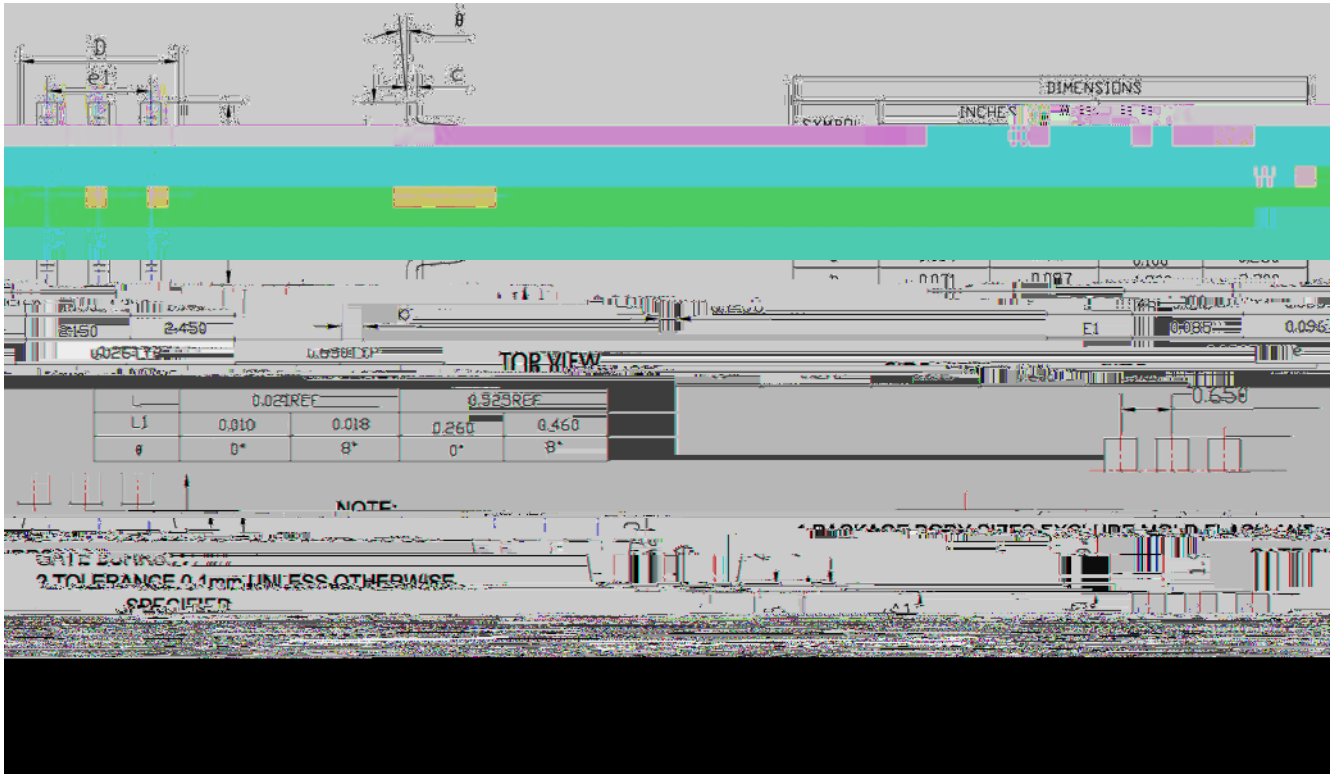

v 0 D U N L Q J , Q I R U P D W L R Q

1 R W H

'LVFODLPHU

7KH LQIRUPDWLRQ LSU ~~SRFH~~ ~~PH~~ ~~HWL~~ ~~QVM~~ ~~RU~~ <DQJJKRX <DQJMLH (OHFWURQLF 7HHKQRO  
ULJKW WR PDNH FKDQJHV ZLKB€@ p HPK°