



1 &KDQQHO (QKDQFHPHQW 0RGH)LHOG (

3URGXFW 6XPPDU\

" 9₆ 9

" ' \$

" 5₆ 2₁ DW 9 9 Ø P

" (\$6 7HVWHG

" j 9₆ 7HVWHG

*HQHUDO 'HVFULSWLRQ

" 6SOLW JDWH WUHQFK 026)(7 WHFKQRORJ

" ([FHOOHQW 8 DFNW HGLR VLSDWLRQ

" +LJK GHQVLW\ FHOQ GHVLJQ IRU ORZ 5

" 0RLVWXUH 6HQVLWLYLW\ /HYHO

" (SR[\ 0HHWV 8)ODPDELOLW\ 5DWLQJ

" +DORJHQ)UHH

" 3DUW QR ZLWKHQXIVL\$(& 4 TXDOLILHG

\$SSOLFDWLRQV

" 3RZHU VZLWFKLQJ DSSOLFDWLRQ

" 8QLQWHUUXSWLEOH SRZHU VXSSO\

" '& '& FRQYHUWU

v \$EVROXWH 0D[LXP 5 5DWLQJ MVV RWKHUZLVH QRWHG

3DUDPHWHU	6\PERO	/LPLW	8QLW
'UDLQ VRXUFH 9ROWDJH	9 ₆		9
*DWH VRXUFH 9ROWDJH	9 ₆	9 "	9
7 _s -			

'UDLQ &XUUHQW

7_s - 7

\$

7 _s -			
7 _s -	3		:

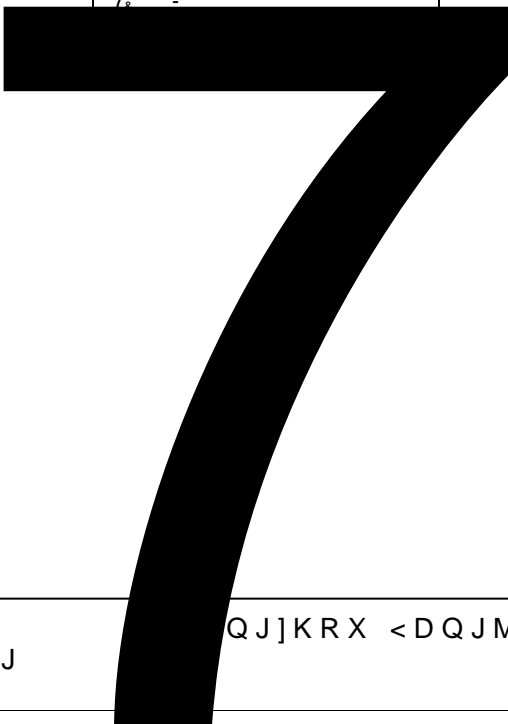



< - * * + + 4

v(OHFWULFDO & KDUDFWXUDLWLRW KHUZLVH QRWHG

3DUDPHWHU	6\PERC	&RQGLWLRQV	0LQ	7\S	0D[8QLWV
6WDWLF 3DUDPHWHU						

'UDLQ 6RXUFH %UHDNGRZQ 9ROWDJH +6 %9, 9



v7\SLFDO (OHFWULFDO DQG 7KHUPDO &KDUDFWHULVWLFV 'LDJUDP

\$

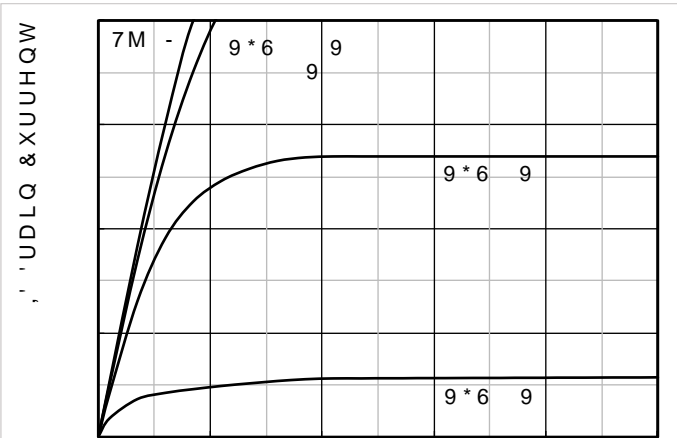

9'6 'UDLQ WR 6RXUFH 9ROWDJH

\$

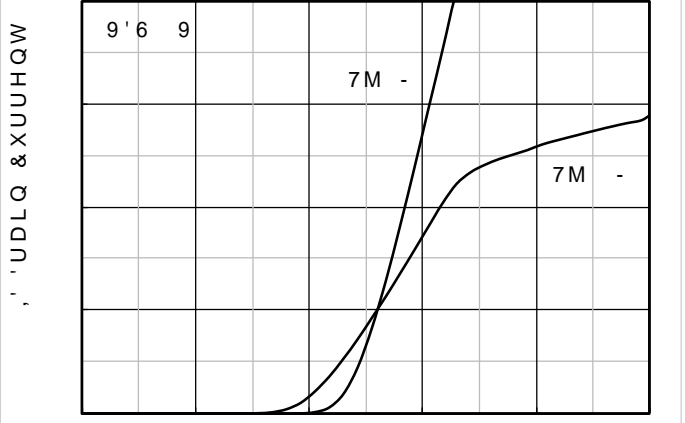

9*6 *DWH WR 6RXUFH 9ROWDJH 9

)LJXUH

2XWSXW &KDUDFWHULVWLFV

)LJXUH

7UDQVIHU &KDU

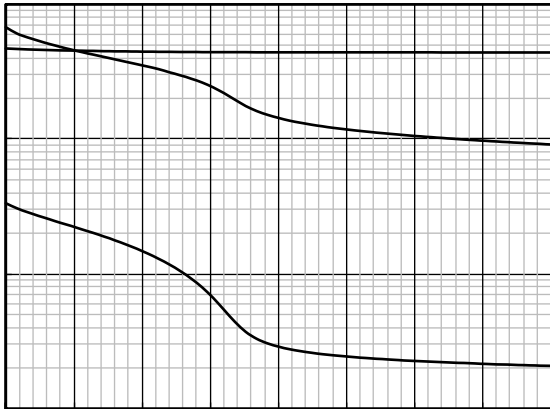

5'6 RQ 'UDLQ WR 6RXUFH UHV L

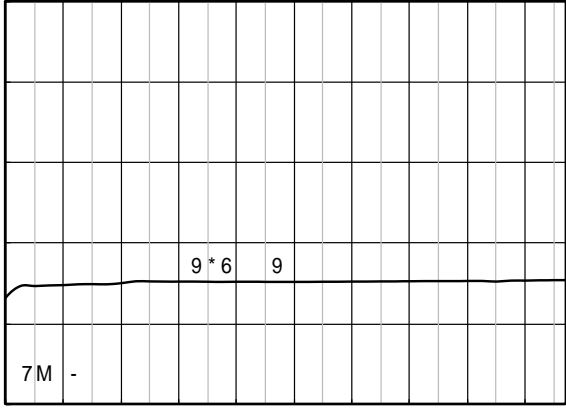

, 'UDLQ &XUHQW \$





< - *

* \$

++4

=WK& 7KHUPDO 5HVL:VWDQFH

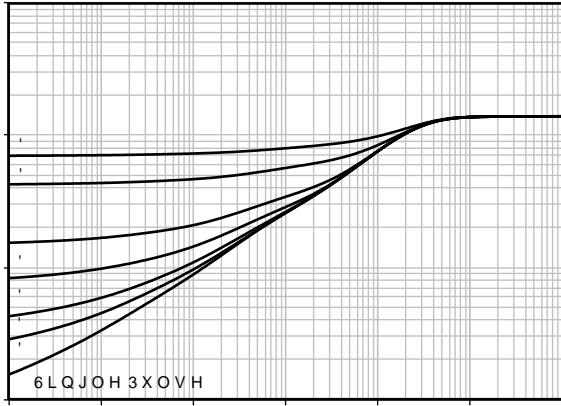

6TXDUH :DYH 3XOVH 'XUWLRQ 6

, 'UDLQ 6RXUFH & XUHQW

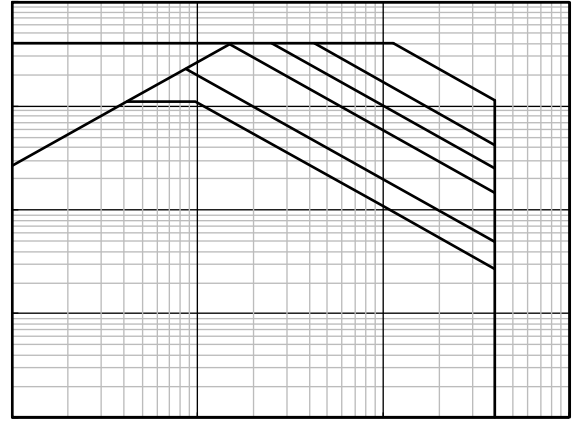

9'6 'UDLQ WRa#uh'C TM UC 3 WQ3 C

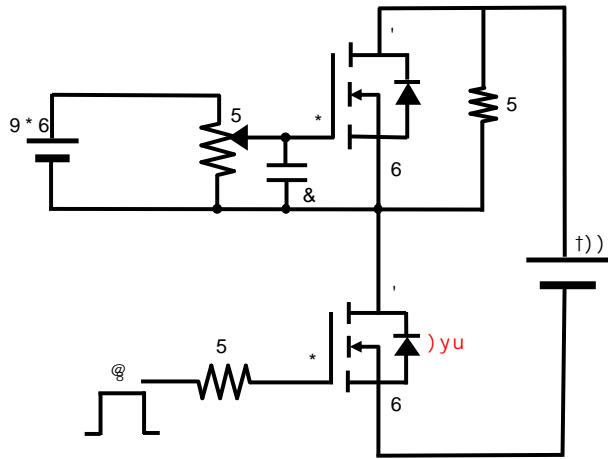



v 3')1 / 00 D3 FNDJH LQIRUPDWLRQ

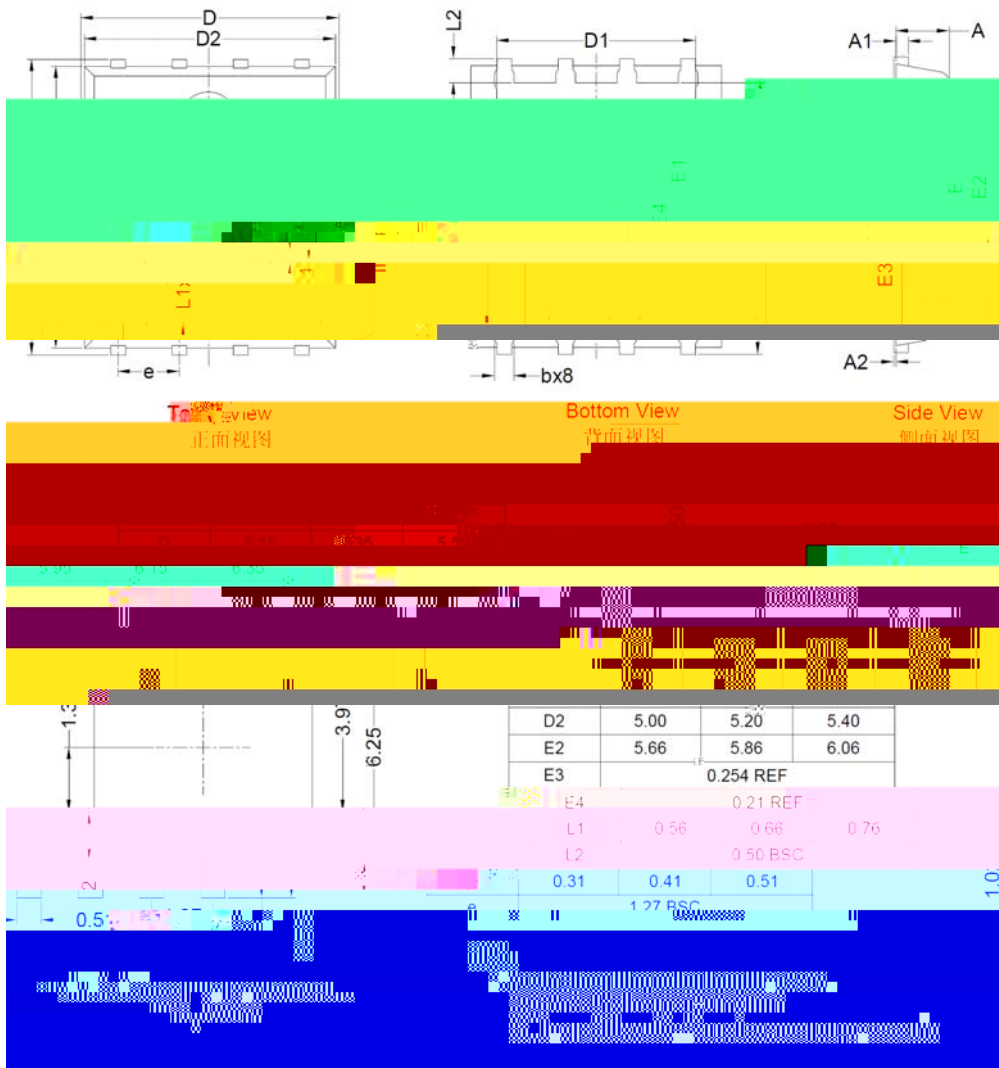



< - * * + + 4
