







Typical Electrical and Thermal Characteristics Diagrams

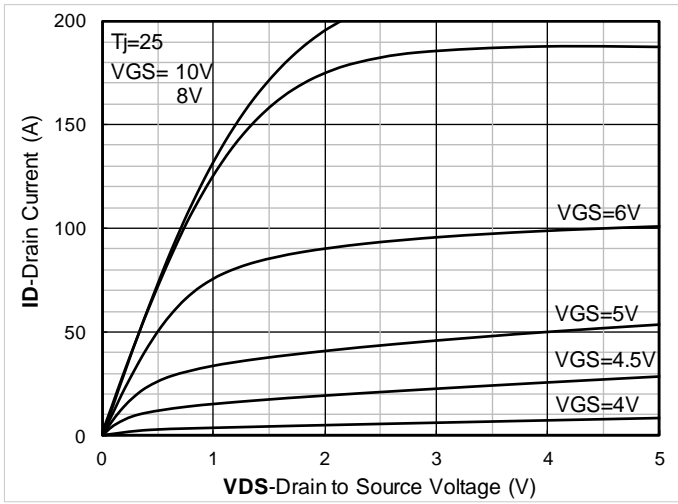

Figure 1. Output Characteristics



Figure 2. Transfer Characteristics

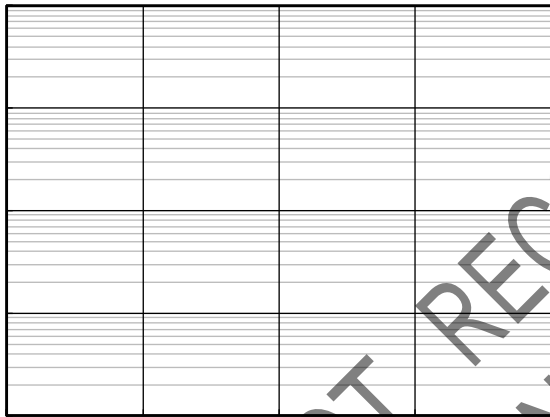
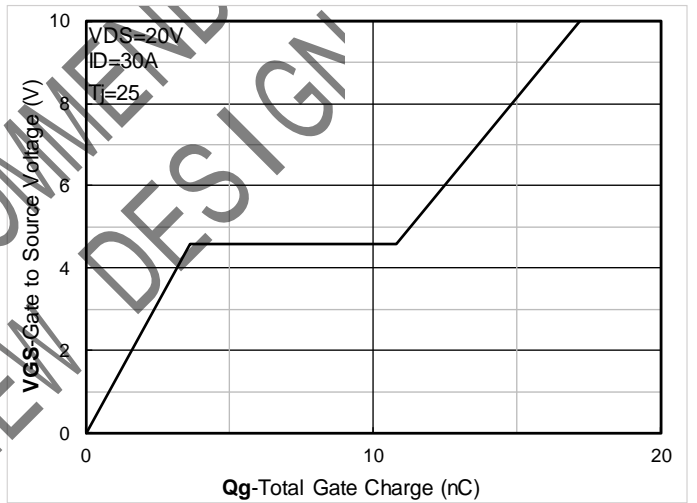

Figure 3. Capac Characteristics



Fre 4. Gate Charge

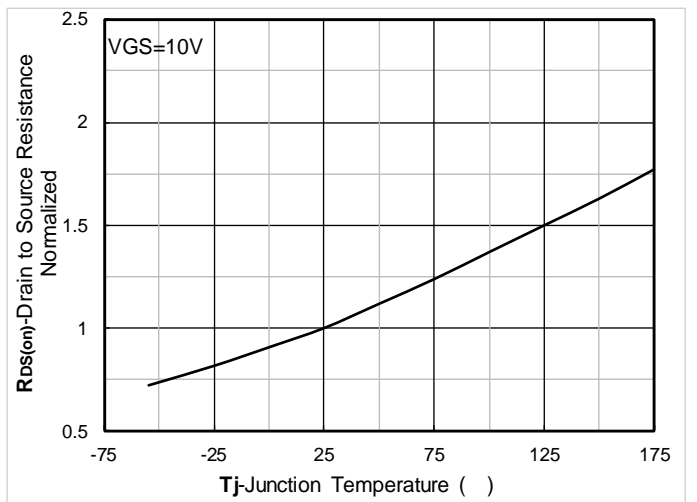
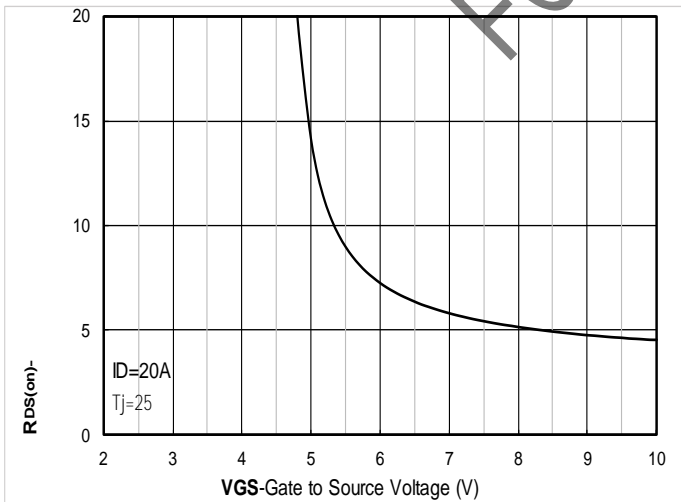

Figure 5. On-ResistQ3.996(a493vt )-8.002(V)E(TD5)TJETQq0 0 596Fr 842.04NoWzIB7D0-96sITQ661 91.824 Td(G)-

**YJG65G04H**

RECOMMEND  
YJG65G04HHQ  
FOR NEW DESIGN

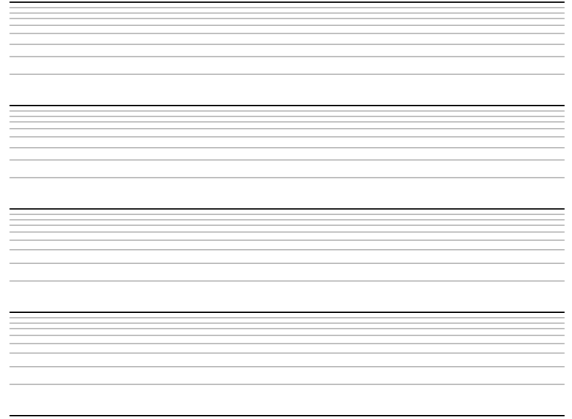

Figure 13. Maximum Transient Thermal Impedance

Figure 14. Safe Operation Area

NOT RECOMMENDED  
FOR NEW DESIGN



## PDFN5060-8L Package information

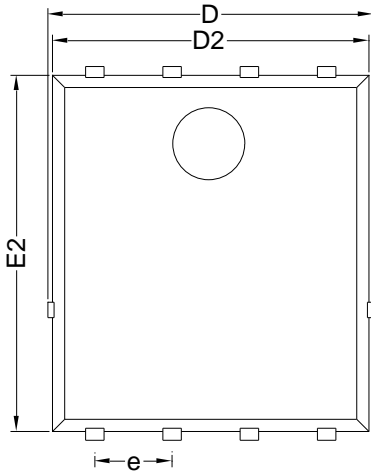

Top View

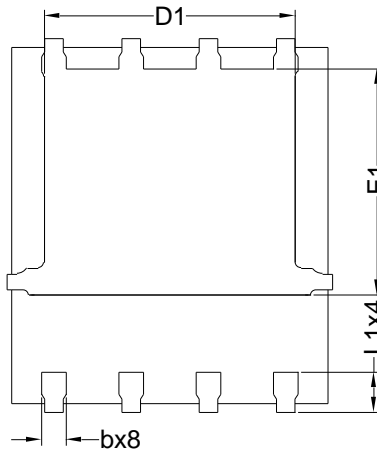

Bottom View

Side View

SYMBOL	MILLIMETER		
	MIN	NOM	MAX
D	5.15	5.35	5.55
E	5.95	6.15	6.35
A	1.00	1.10	1.20
A1	0.254 BSC		
A2			0.10
D1	3.92	4.12	4.32
E1	3.52	3.72	3.92
D2	5.00	5.20	5.40
E2	5.66	5.86	6.06
E3	0.254 REF		
E4	0.21 REF		
L1	0.56	0.66	0.76
L2	0.50 BSC		
b	0.31	0.41	0.51
e	1.27 BSC		

Note:

1. Controlling dimension: in millimeters.
2. General tolerance:  $\pm 0.10$  mm.
3. The pad layout is for reference purposes only.

RECOMMEND  
YJG65G04HHQ  
FOR NEW DESIGN