

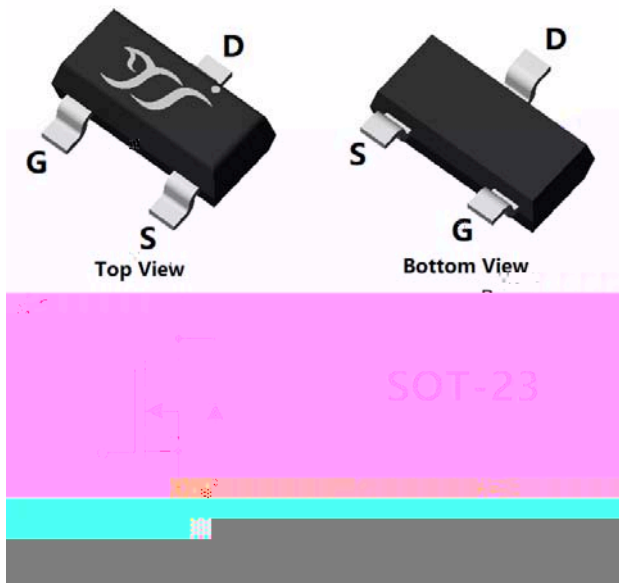

N-Channel Enhancement Mode Field Effect Transistor



Product Summary

V_{DS}	60V
I_D	3A
$R_{DS(ON)}$ (at $V_{GS}=10V$)	80m
$R_{DS(ON)}$ (at $V_{GS}=4.5V$)	95m

General Description

Trench Power LV MOSFET technology
 High Speed switching
 Halogen Free
 Moisture Sensitivity Level 1
 Epoxy Meets UL 94 V-0 Flammability Rating
 Halogen Free

Applications

Power switching application
 Uninterruptible power supply
 PWM application

Absolute Maximum Ratings ($T_A=25$ unless otherwise noted)

Parameter		Symb		
		V_{DS}	60	V
Gate-source Voltage		V_{GS}	- 20	V
Drain Current	$T_A=25$	I_D	3	A
	$T_A=100$		1.9	
Pulsed Drain Current ^A		I_{DM}	20	A
Total Power Dissipation ^B	$T_A=25$	P_D	1.2	W
	$T_A=100$		0.45	
Junction and Storage Temperature Range		T_J, T_{STG}	-55 +150	

Thermal resistance

Parameter		Symbol	Typ	Max	Units
Thermal Resistance Junction-to-Ambient ^C	Steady-State	R_{JA}	85	105	/W

Ordering Information (Example)

PREFERRED P/N	PACKING CODE	Marking	MINIMUM PACKAGE(pcs)	INNER BOX QUANTITY(pcs)	OUTER CARTON QUANTITY(pcs)	DELIVERY MODE
YJL03N06C	F2	03N06C.	3000	30000	120000	7" reel

YJL03N06C



Typical Electrical and Thermal Characteristics Diagrams

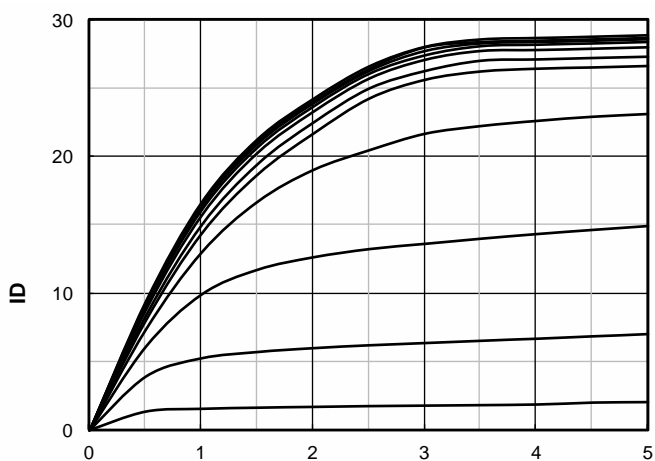



YJL03N06C

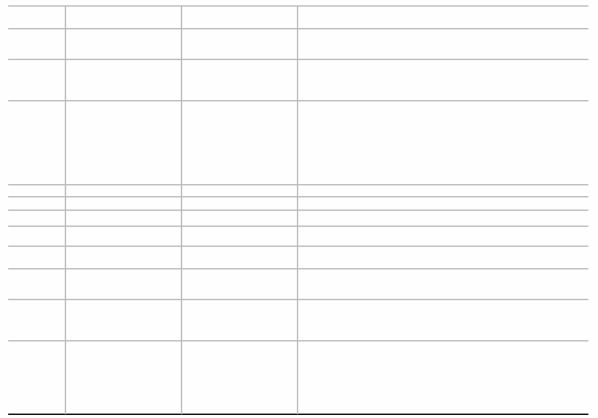
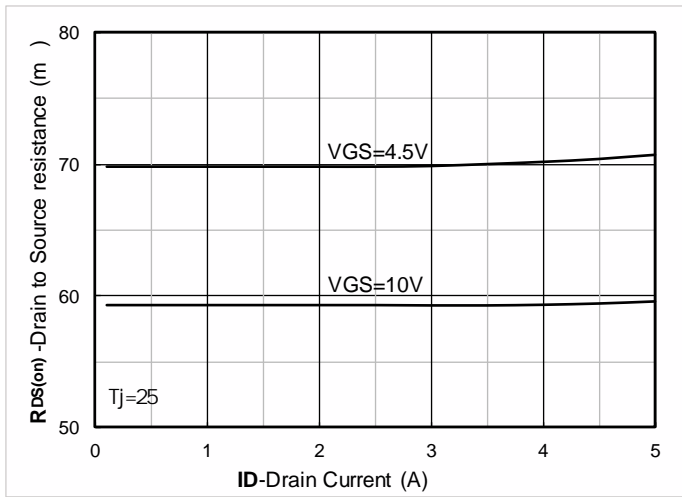

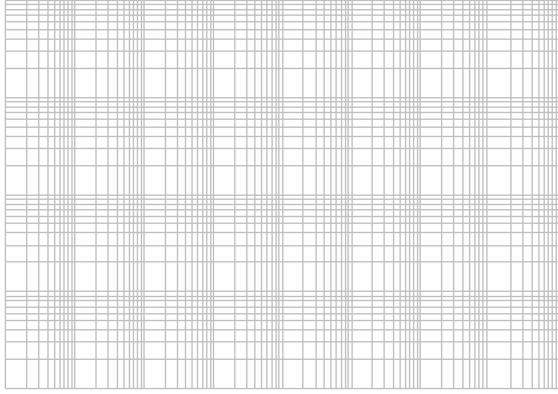



YJL03N06C

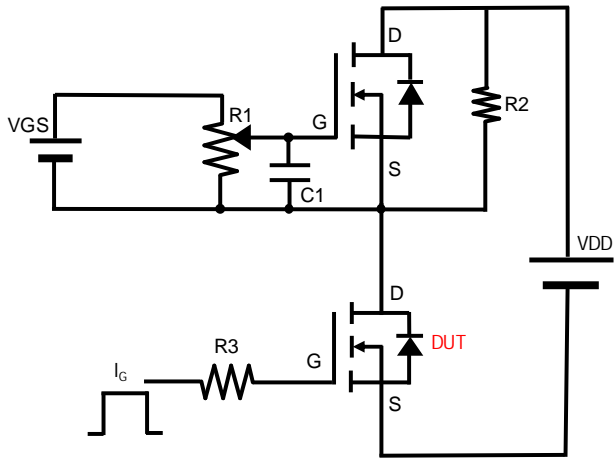



SOT-23 Package information

TOP VIEW

SIDE VIEW

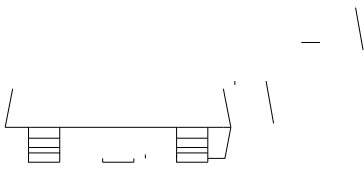

UNIT mm

SUGGESTED SOLDER PAD LAYOUT



Disclaimer

The information presented in this document is for reference only. Yangzhou Yangjie Electronic Technology Co., Ltd. reserves the right to make changes without notice for the specification of the products displayed herein to improve reliability, function or design or otherwise.

The product listed herein is designed to be used with ordinary electronic equipment or devices, and not designed to be used with equipment or devices which require high level of reliability and the malfunction of which would directly endanger human life (such as medical instruments, transportation equipment, aerospace machinery, nuclear-reactor controllers, fuel controllers and other safety devices), Yangjie or anyone on its behalf, assumes no responsibility or liability for any damages resulting from such improper use of sale.

This publication supersedes & replaces all information previously supplied. For additional information, please visit our website <http://www.21yangjie.com> , or consult your nearest Yangjie's sales office for further assistance.