

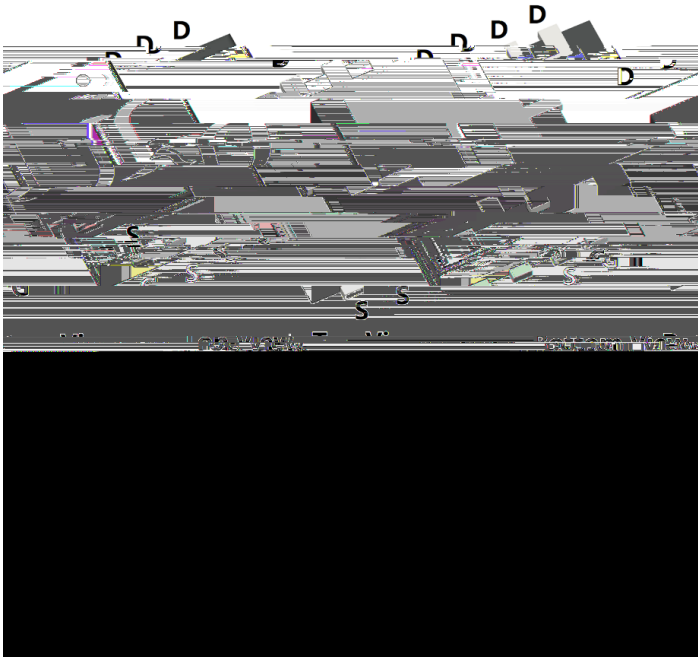

YJQ100G03AJR

N-Channel Enhancement Mode Field Effect Transistor



Product Summary

V_{DS}	30V
I_D	100A
$R_{DS(ON)}$ (at $V_{GS}=10V$)	2.1m
$R_{DS(ON)}$ (at $V_{GS}=4.5V$)	4.5m
100% EAS Tested	
100% V_{DS} Tested	

General Description

Split gate trench MOSFET technology
 Excellent package for heat dissipation
 High density cell design for low $R_{DS(ON)}$
 Moisture Sensitivity Level 1
 Epoxy Meets UL 94 V-0 Flammability Rating
 Halogen Free

Applications

Power switching application
 Uninterruptible power supply
 DC-DC convertor

Absolute Maximum Ratings ($T_A=25$ unless otherwise noted)

Parameter		Symbol	Limit	Unit
Drain-source Voltage		V_{DS}	30	V
Gate-source Voltage		V_{GS}	± 20	V
Drain Current	$T_A=25$	I_D	24	A
	$T_A=100$		15	
	$T_C=25$		100	
	$T_C=100$		63	
Pulsed Drain Current ^A		I_{DM}	400	A
Avalanche energy ^B		EAS	162	mJ
Total Power Dissipation ^C	$T_A=25$	P_D	2.5	W
	$T_A=100$		1	
	$T_C=25$		50	
	$T_C=100$		20	
Junction and Storage Temperature Range		T_J, T_{STG}	-55 +150	

Thermal resistance

Parameter		Symbol	Typ	Max	Units
Thermal Resistance Junction-to-Ambient ^D	Steady-State	R_{JA}	40	50	/W
Thermal Resistance Junction-to-Case	Steady-State	R_{JC}	2	2.5	

Ordering Information (Example)

PREFERRED P/N	PACKING CODE	Marking	MINIMUM PACKAGE(pcs)	INNER BOX QUANTITY(pcs)	OUTER CARTON QUANTITY(pcs)	DELIVERY MODE
YJQ100G03AJR	F1	100G03A	5000	10000	100000	13" reel



YJQ100G03AJR

Electrical Characteristics (T_J=25 unless otherwise noted)

Parameter	Symbol	Conditions	Min	Typ	Max	Units
Static Parameter						
Drain-Source Breakdown Voltage	BV _{DSS}	V _{GS} = 0V, I _D =250μA	30	-	-	V
Zero Gate Voltage Drain Current	I _{DSS}	V _{DS} =30V, V _{GS} =0V	-	-	1	μA
		V _{DS} =30V, V _{GS} =0V, T _J =150	-	-	100	
Gate-Body Leakage Current	I _{GSS}	V _{GS} = ±20V, V _{DS} =0V	-	-	±100	nA
Gate Threshold Voltage	V _{GS(th)}	V _{DS} = V _{GS} , I _D =250μA	1.2	1.7	2.5	V
Static Drain-Source On-Resistance	R _{DS(ON)}	V _{GS} =10V, I _D =50A	-	1.6	2.1	m
		V _{GS} =10V, I _D =20A	-	1.6	2.1	
		V _{GS} =4.5V, I _D =20A	-	2.5	4.5	
Diode Forward Voltage	V _{SD}	I _S =50A, V _{GS} =0V	-	-	1.2	V
Gate resistance	R _G	f=1MHz	-	3	-	
Maximum Body-Diode Continuous Current	I _S		-	-	100	A
Dynamic Parameters						
Input Capacitance	C _{iss}	V _{DS} =15V, V _{GS} =0V, f=500KHz	-	2630	-	pF
Output Capacitance	C _{oss}		-	1830	-	
Reverse Transfer Capacitance	C _{rss}		-	100	-	
Switching Parameters						
Total Gate Charge	Q _g	V _{GS} =10V, V _{DS} =15V, I _D =50A	-	45	-	nC
Gate-Source Charge	Q _{gs}		-	17	-	
Gate-Drain Charge	Q _{gd}		-	8	-	
Reverse Recovery Charge	Q _{rr}	I _F =50A, di/dt=100A/us	-	40	-	n 1 32S



Typical Electrical and Thermal Characteristics Diagrams

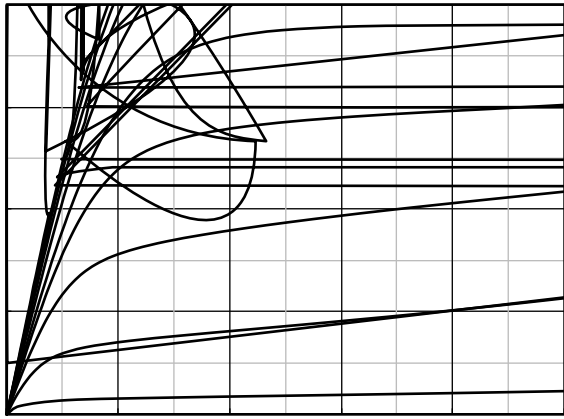

Figure 1. Output Characteristics

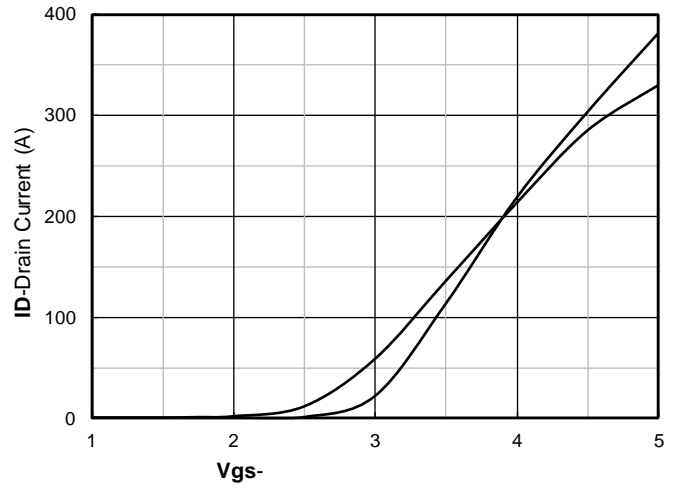

Figure 2. Transfer Characteristics



Figure 3. Capacitance Characteristics

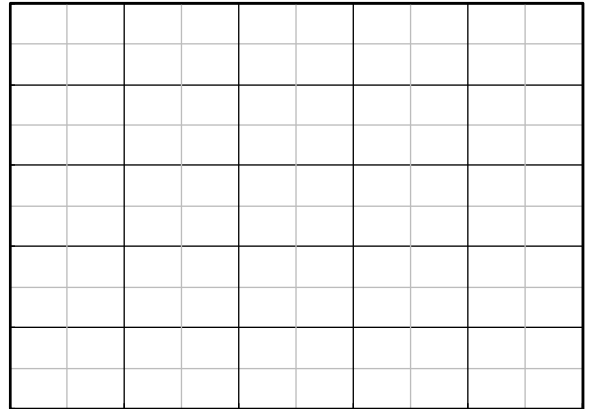

Figure 4. Gate Charge

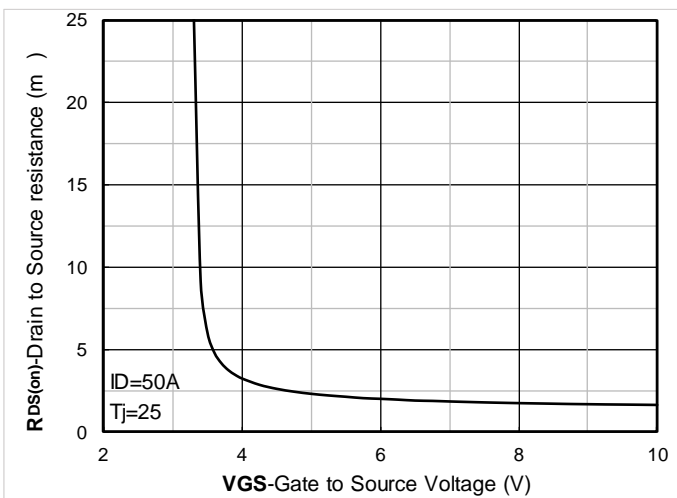

Figure 5. On-Resistance vs Gate to Source Voltage

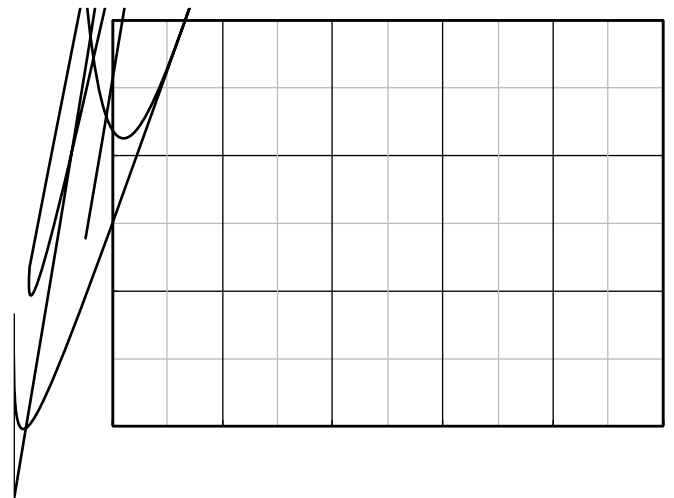

Figure 6. Normalized On-Resistance

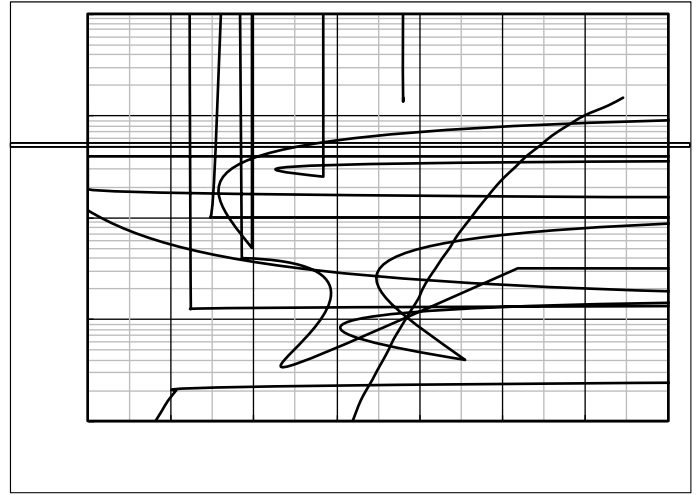

Figure 8. Forward characteristics of reverse diode

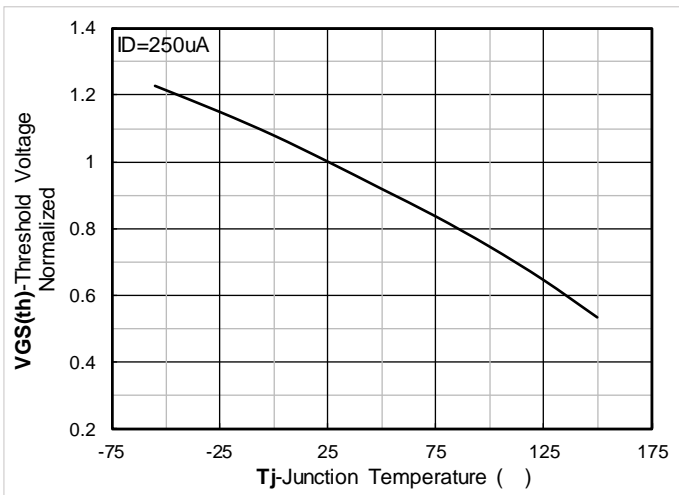

Figure 9. Normalized Threshold voltage

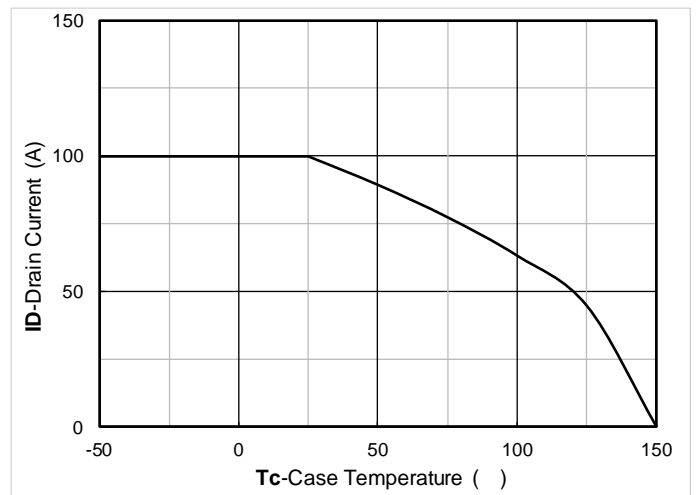

Figure 10. Current dissipation

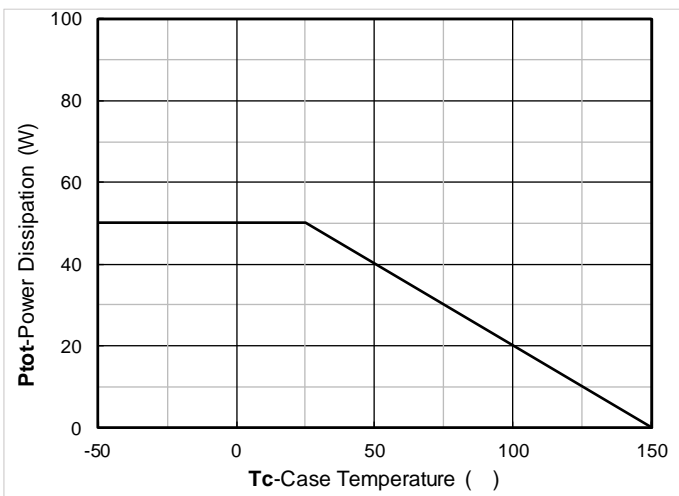

Figure 11. Power dissipation

Figure 12. Maximum Transient Thermal Impedance

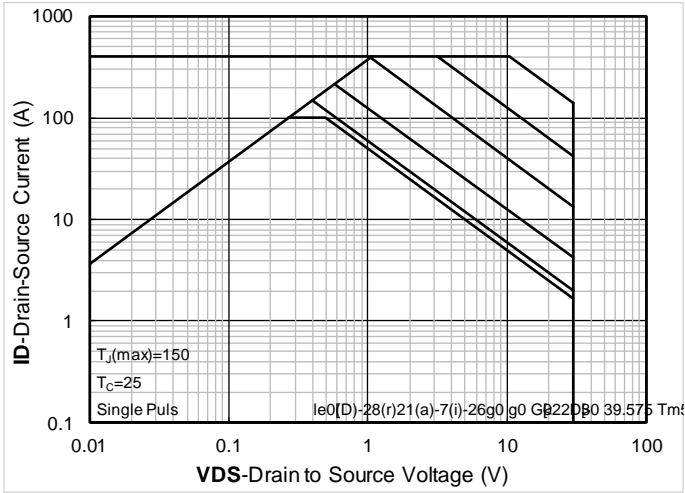

Figure 13. Safe Operation Area

Test Circ1P AMCID 7Lang (en-US)>BDC 00000888 0 5Bit*nBT/F2108 Tf1 0 0 1 9 90m0 g0 G(Q1)ETQ



YJQ100G03AJR

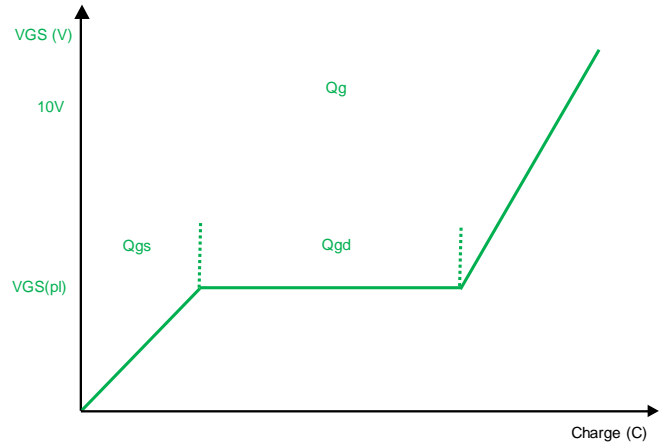
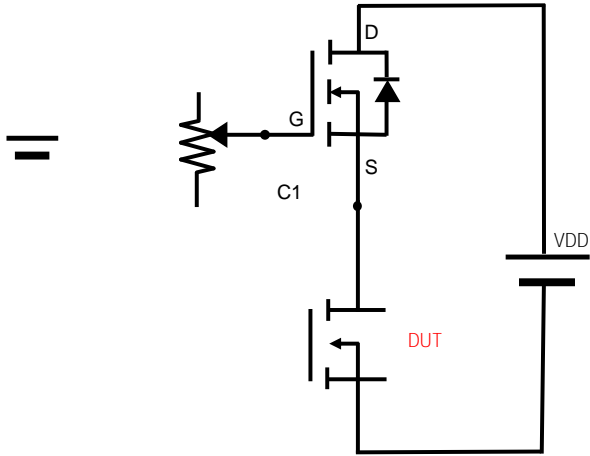

Figure B. Gate Charge Test Circuit & Waveform

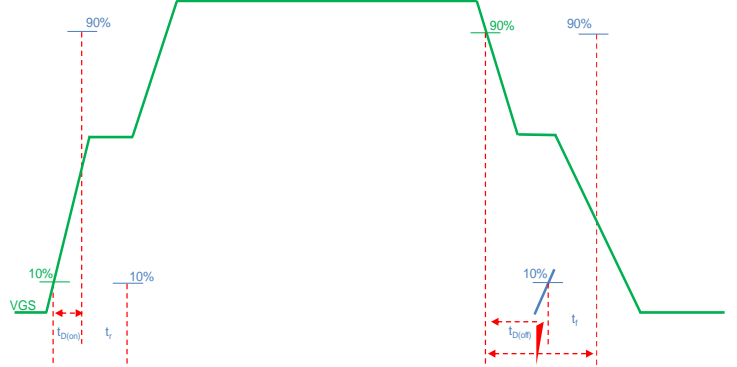

Figure C. Resistive Switching Test Circuit & Waveform

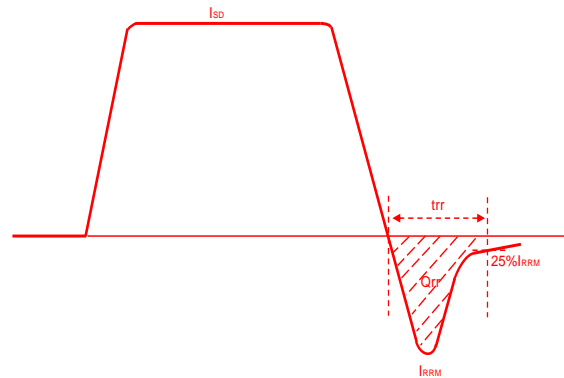
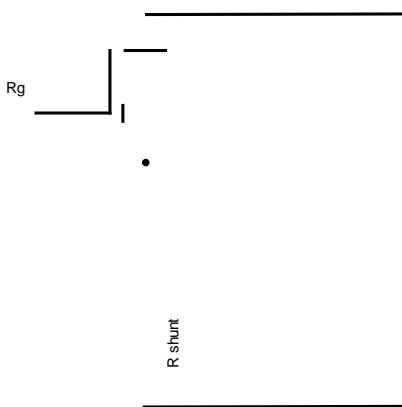
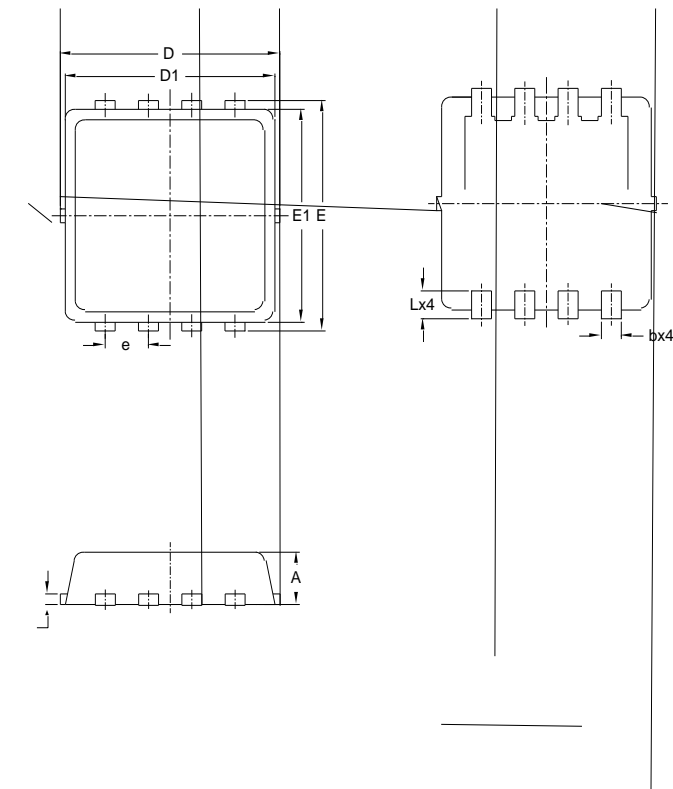

Figure D. Diode Recovery Test Circuit & Waveform



YJQ100G03AJR

PDFN3333-8L Package information



NOTE:

- 1. PACKAGE BODY SIZES EXCLUDE MOLD FLASH AND GATE BURRS.
- 2. TOLERANCE 0.1mm UNLESS OTHERWISE SPECIFIED.
- 3. THE PAD LAYOUT IS FOR REFERENCE PURPOSES ONLY.

UNIT mm

