

Dual NPN Small Signal Transistor



Features

- Epoxy meets UL-94 V-0 flammability rating
- Surface mount package ideally Suited for Automatic Insertion
- NPN

Mechanical Data

Package: SOT-363

Terminals: Tin plated leads, solderable per J-STD-002 and JESD22-B102

Marking: K2X

Equivalent circuit

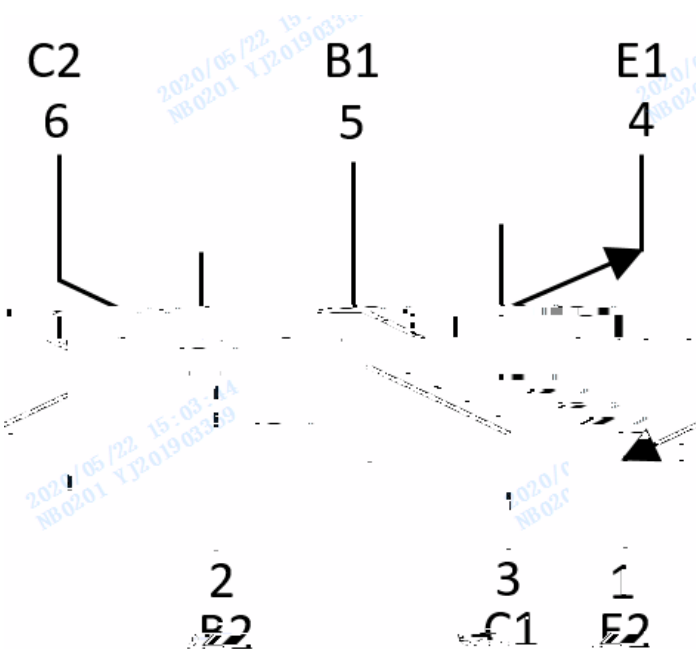

Collector-Base Voltage	VCBO	V	IC=100μA,IE=0	60
Collector-Emitter	0			



MMDT4401

Ordering Information (Example)

PREFERRED P/N	PACKING CODE	UNIT WEIGHT(g)	MINIMUM PACKAGE(pcs)	INNER BOX QUANTITY(pcs)	OUTER CARTON QUANTITY(pcs)	DELIVERY MODE
MMDT4401	F2	Approximate 0.009g	3000	30000	120000	7" reel

Characteristics (Typical)

Static Characteristic

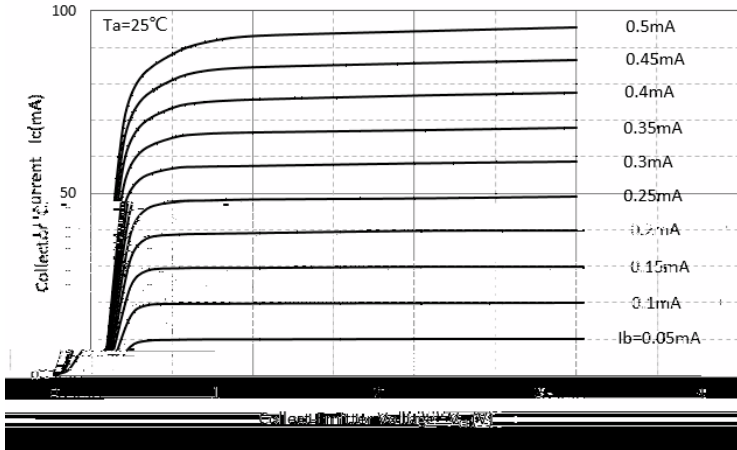

DC Current Gain

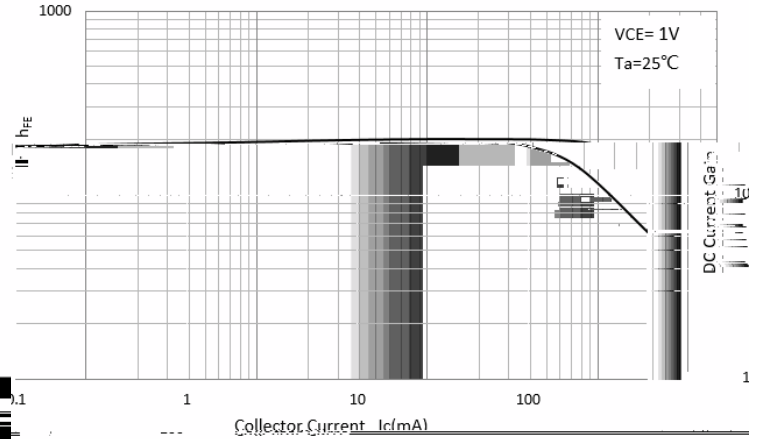

Collector-Emitter Saturation Voltage

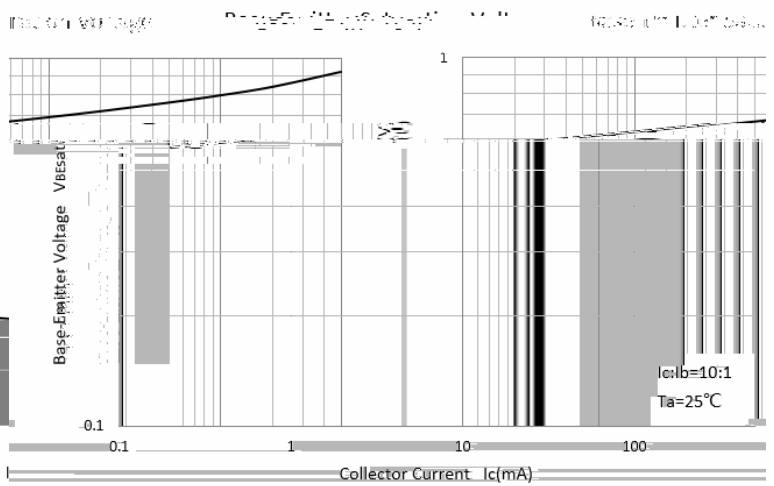
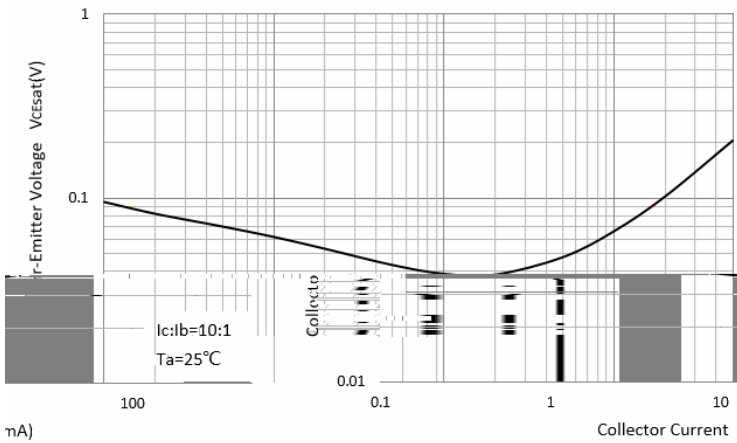

Base-Emitter On Voltage

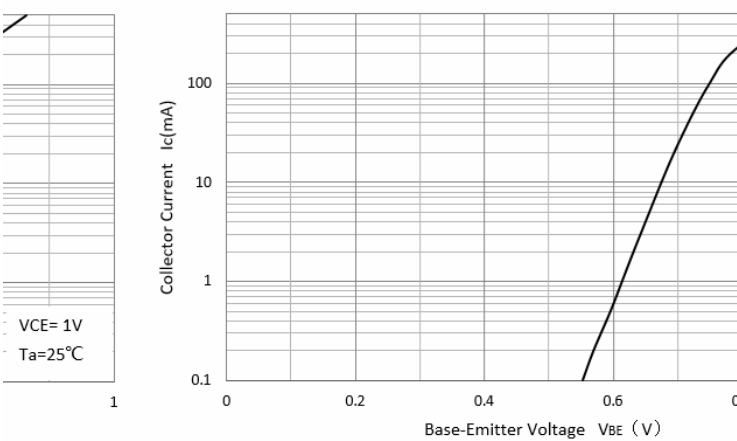

Cob/Cib-V_{CB}/V_{EB}

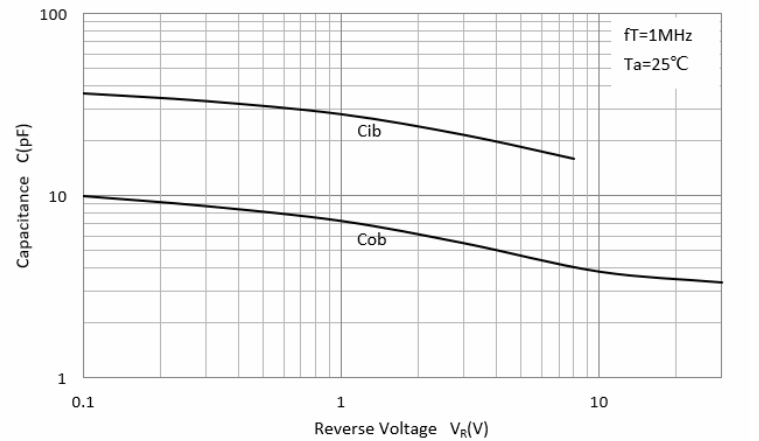



MMDT4401

SOT-363 Package Outline Dimensions

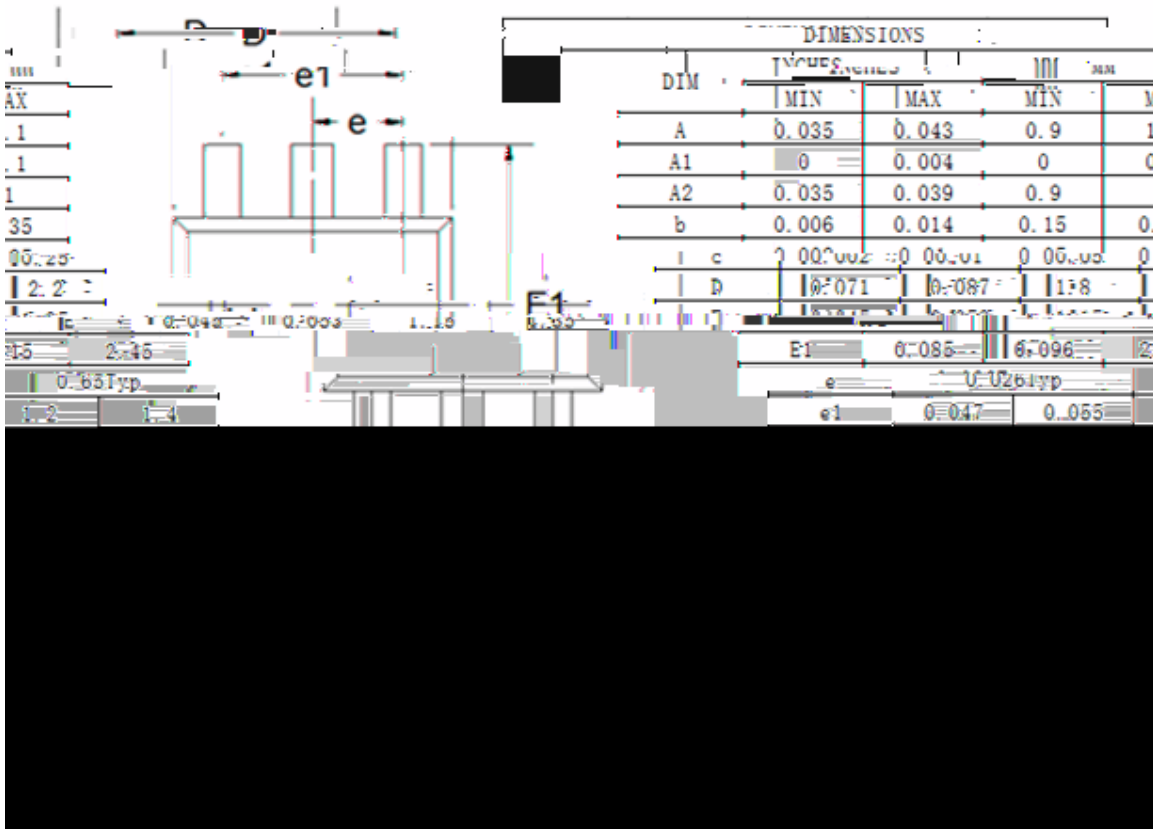

SOT-363 Soldering Footprint

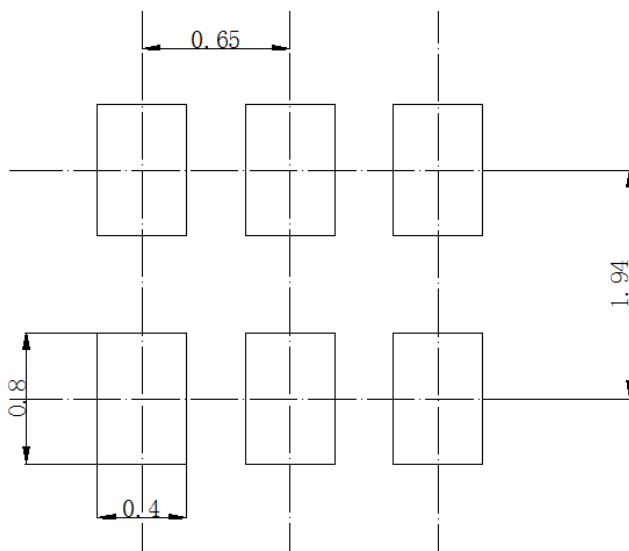

Unit Ömm



Disclaimer

The information presented in this document is for reference only. Yangzhou Yangjie Electronic Technology Co., Ltd. reserves the right to make changes without notice for the specification of the products displayed herein to improve reliability, function or design or otherwise.

The product listed herein is designed to be used with ordinary electronic equipment or devices, and not designed to be used with equipment or devices which require high level of reliability and the malfunction of which would directly endanger human life (such as medical instruments, transportation equipment, aerospace machinery, nuclear-reactor controllers, fuel controllers and other safety devices), Yangjie or anyone on its behalf, assumes no responsibility or liability for any damages resulting from such improper use of sale.

This publication supersedes & replaces all information previously published for the purpose of providing the most current information.