

Dual NPN+PNP Small Signal Transistor



Features

- Epoxy meets UL-94 V-0 flammability rating
- Surface mount package ideally Suited for Automatic Insertion
- NPN/PNP

Max. Power Dissipation 300mW

Ordering Information (Example)

			PACKAGE(pcs)	INNER BOX QUANTITY(pcs)	OUTER CARTON QUANTITY(pcs)	DELIVERY MODE
MMDT5451	F2	Approximate 0.009g	3000	30000	120000	7" reel



MMDT5451

TR1 PNP Pin3 4 5 Maximum Ratings (Ta=25 Unless otherwise specified)

Item	Symbol	Unit	Conditions	Value
Collector-Base Voltage	VCBO	V	IC=-100 μ A,IE=0	-160
Collector-Emitter Voltage	VCEO	V	IC=-1mA,IB=0	-150
Emitter-Base Voltage	VEBO	V	IE=-10 μ A,IC=0	-5
Collector Current -Continuous	IC	mA		-200



MMDT5451

TR2 NPN Pin1 2 6 Maximum Ratings (Ta=25 Unless otherwise specified)

Item	Symbol	Unit	Conditions	Value
Collector-Base Voltage	VCBO	V	IC=100μA,IE=0	180
Collector-Emitter Voltage	VCEO	V	IC=1mA,IB=0	160
Emitter-Base Voltage	VEBO	V	IE=10μA,IC=0	6
Collector Current -Continuous	IC	mA		200
Total Device Dissipation	PC	mW		200
Junction Temperature	Tj			150
Storage Temperature	TSTG			-55 to +150

TR2 NPN Pin1 2 6 Electrical Characteristics (Ta=25 unless otherwise specified)

Item	Symbol	Unit	Conditions	Min	TYP	Max
Collector-base breakdown voltage	VCBO	V	IC=100μA,IE=0	180		
Collector-emitter breakdown voltage	VCEO	V	IC=1mA,IB=0	160		
Emitter-base breakdown voltage	VEBO	V	IE=10μA,IC=0	6		
Collector cut-off current	ICBO	nA	VCB=120V,IE=0			50
Emmitter cut-off current	IEBO	nA	VEB=4V, IC=0			50
DC current gain	hFE1		VCE=5V,IC=1mA	80		
	hFE2		VCE=5V,IC=10mA	100		300
	hFE3		VCE=5V,IC=50mA	30		
Collector-emitter saturation voltage	VCE(sat)	V	IC=10mA,IB=1mA			0.15
Collector-emitter saturation voltage	VCE(sat)	V	IC=50mA,IB=5mA			0.2
Base-emitter saturation voltage	VBE(sat)	V	IC=10mA,IB=1mA			1
Base-emitter saturation voltage	VBE(sat)	V	IC=50mA,IB=5mA			1
Transition frequency	fT	MHz	VCE=10V,IC=10mA,f=100MHz	100		300
Output capacitance	Cobo	pF	VCE=10V,IE=0,f=1MHz			6



MMDT5451

TR1 PNP Pin3 4 5 Characteristics (Typical)

Static Characteristic

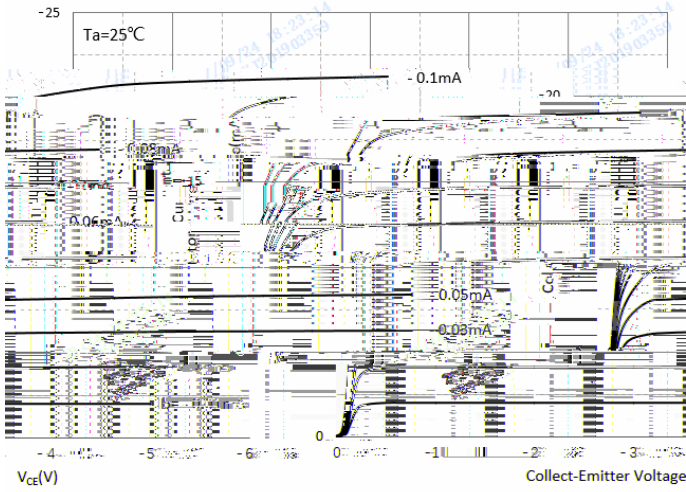

DC Current Gain

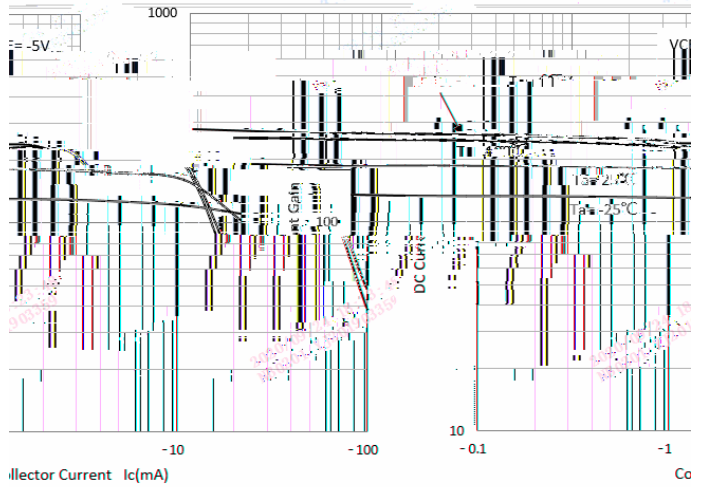

Collector-Emitter Saturation Voltage

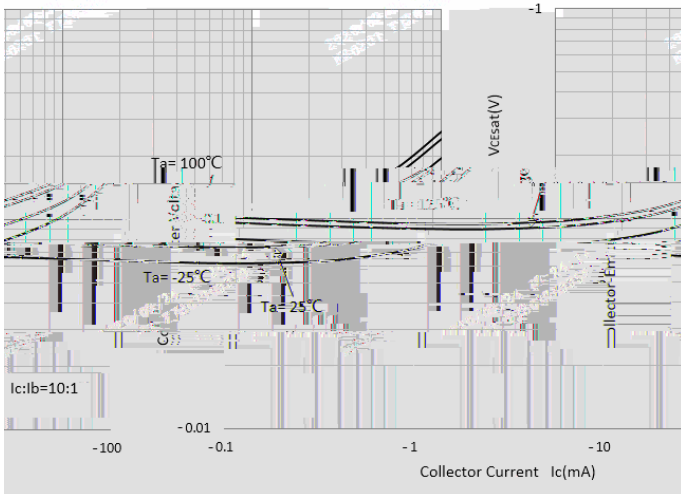

Base-Emitter Saturation Voltage

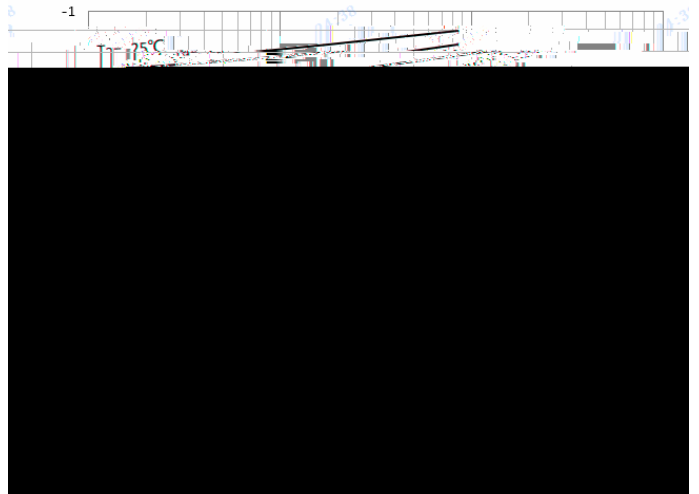

Base-Emitter On Voltage

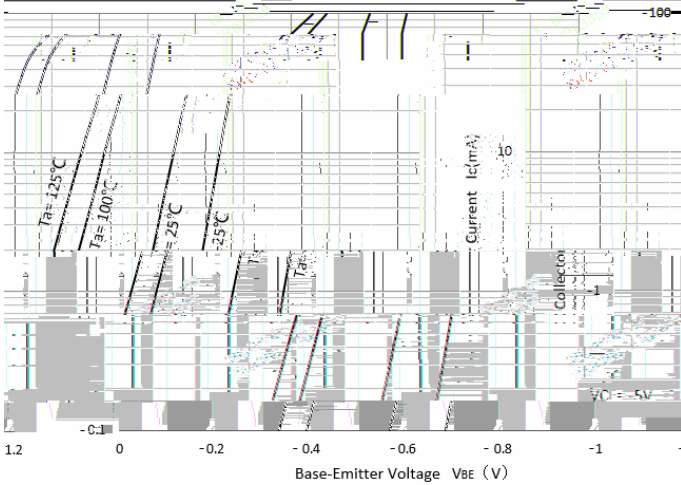

Cob/Cib-V_{CB}/V_{EB}

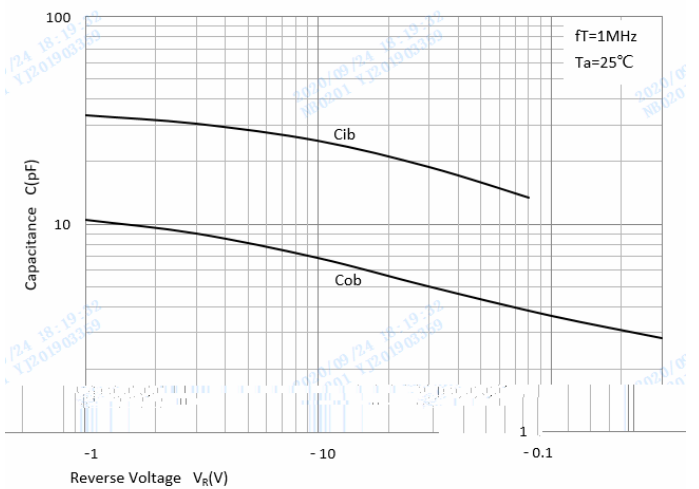



MMDT5451

TR2 NPN Pin1 2 6 Characteristics (Typical)

Static Characteristic

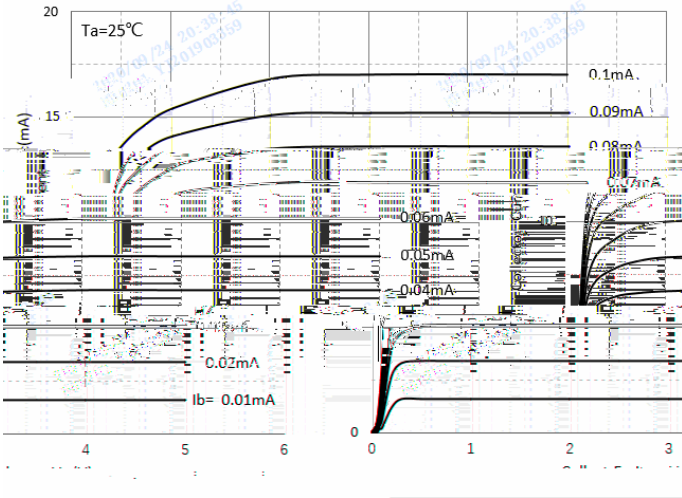

DC Current Gain

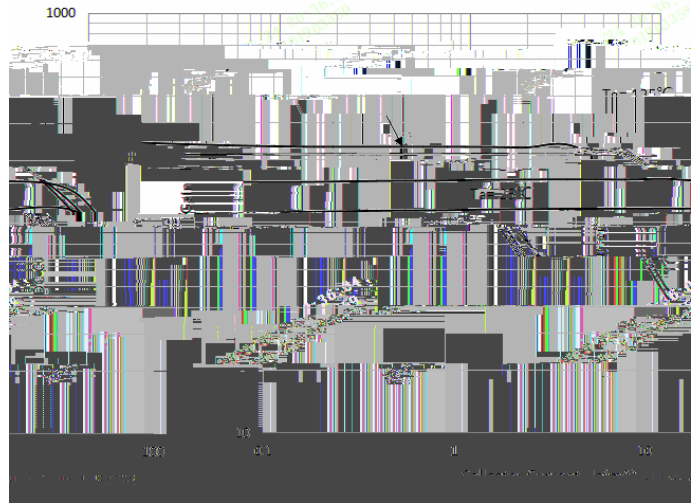

Collector-Emmitter Saturation Voltage

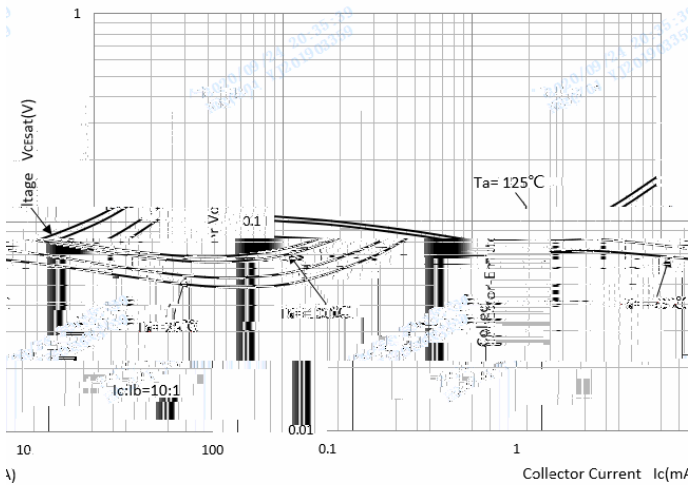

Base-Emmitter Saturation Voltage

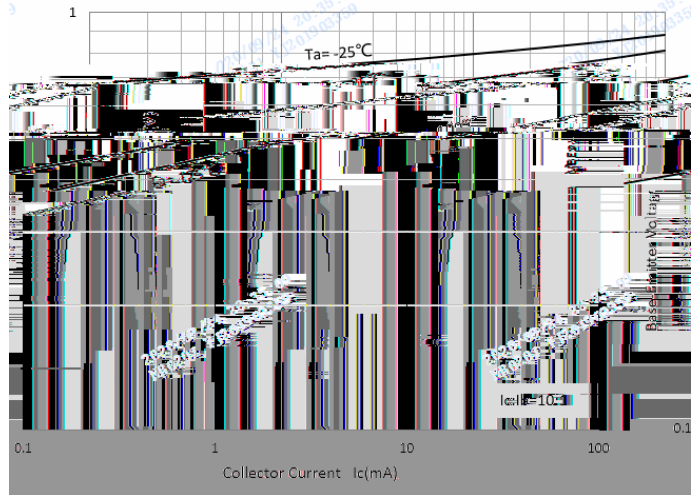

Base-Emmitter On Voltage

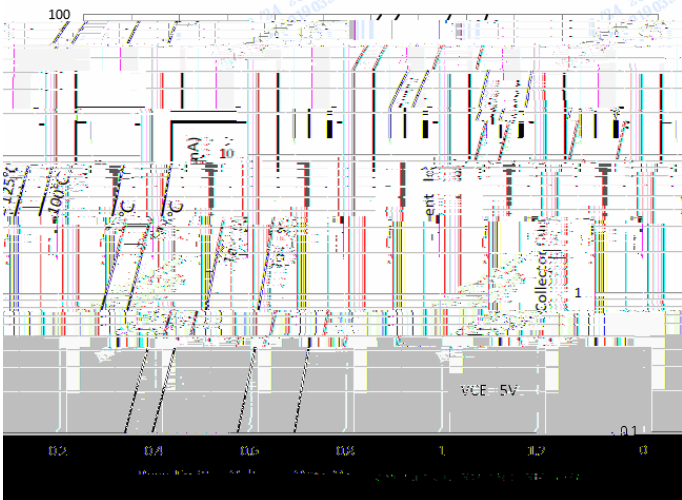

Capacitance

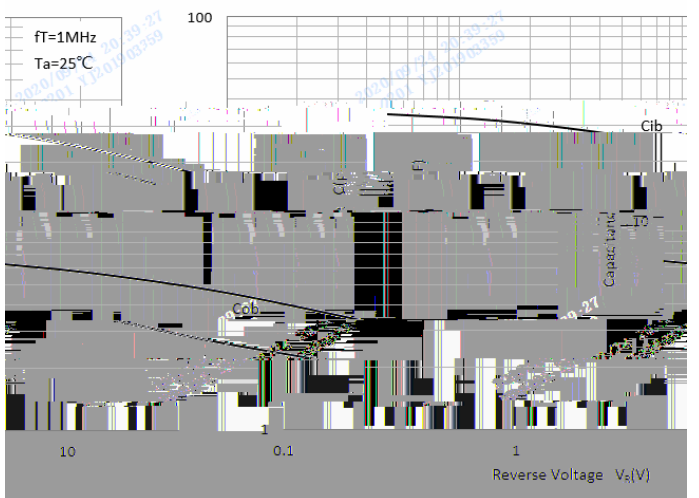

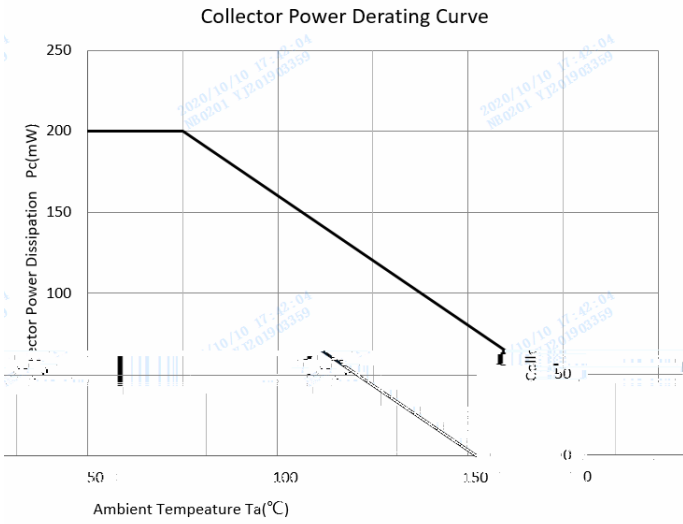

SOT-363 Package Outline Dimensions

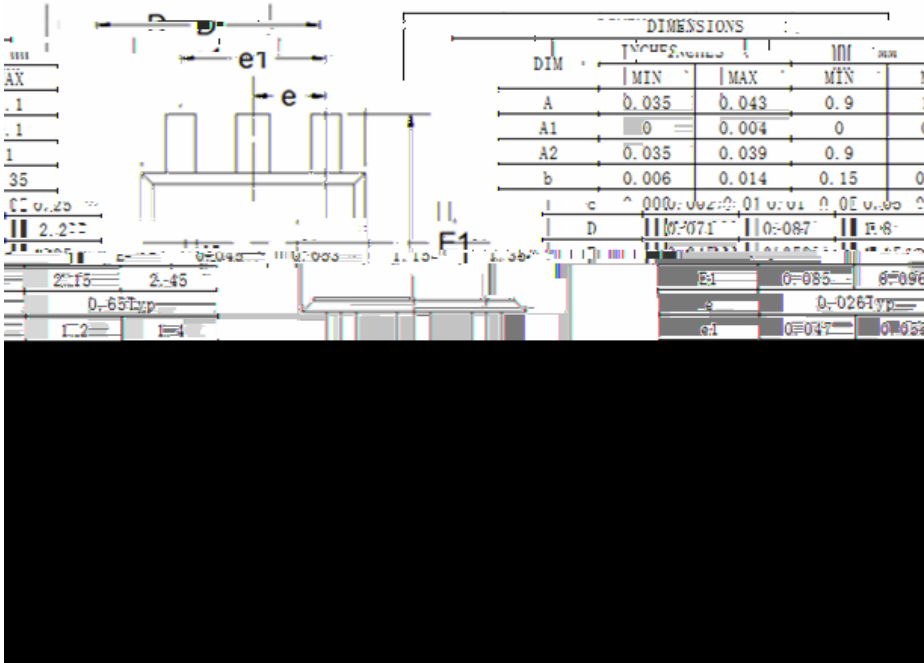

SOT-363 Soldering Footprint

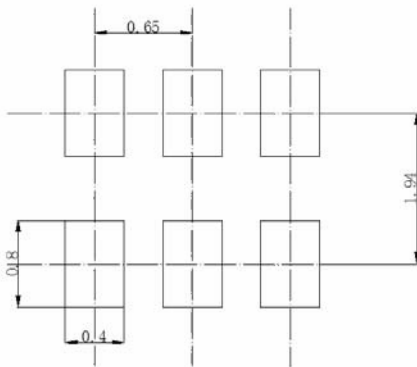

Unit mm



Disclaimer

The information presented in this document is for reference only. Yangzhou Yangjie Electronic Technology Co., Ltd. reserves the right to make changes without notice for the specification of the products displayed herein to improve reliability, function or design or otherwise.

The product listed herein is designed to be used with ordinary electronic equipment or devices, and not designed to be used with equipment or devices which require high level of reliability and the malfunction of which would directly endanger human life (such as medical instruments, transportation equipment, aerospace machinery, nuclear-reactor controllers, fuel controllers and other safety devices), Yangjie or anyone on its behalf, assumes no responsibility or liability for any damages resulting from such improper use of sale.

This publication supersedes & replaces all information previously supplied. For additional information, please visit our website [http:// www.21yangjie.com](http://www.21yangjie.com) , or consult your nearest Yangjie's sales office for further assistance.