

## NPN General Purpose Amplifier

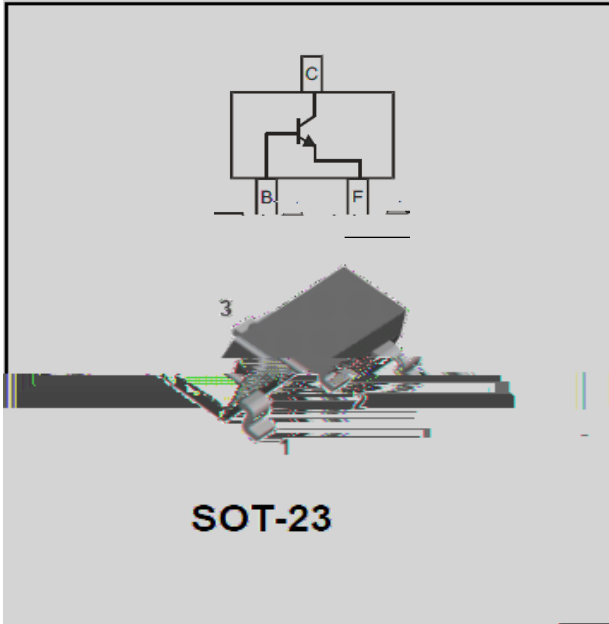

### Features

- High current gain
- Low noise
- High frequency response
- Low power consumption
- High thermal stability
- High reliability
- High precision
- High accuracy
- High resolution
- High speed
- High performance
- High quality
- High efficiency
- High stability
- High precision
- High accuracy
- High resolution
- High speed
- High performance
- High quality
- High efficiency
- High stability

### Applications

- Amplifier
- Driver
- Switch
- Oscillator
- Comparator
- Inverter
- Buffer
- Transistor
- Amplifier
- Driver
- Switch
- Oscillator
- Comparator
- Inverter
- Buffer
- Transistor

### Maximum Ratings

Item	Symbol	Unit	Conditions	Value
------	--------	------	------------	-------

Collector-Emitter Voltage  $V_{CE}$   $V_{CE} = 8V$

Collector Current $I_C$	mA	100		100
Base Current $I_B$	mA	10		10
Power Dissipation $P_D$	mW	100		100
Storage Temperature $T_{STG}$	°C	-55 to 150		-55 to 150
Operating Temperature $T_{OP}$	°C	-55 to 150		-55 to 150

### Ordering Information

PREFERRED P/N	PACKING CODE	UNIT WEIGHT(g)	MINIMUM PACKAGE(pcs)	INNER BOX		
PBSS4230T	08	0.015	1000	10000	100000	100000

v(OHFWULFDO &KÄV

,WHP		Q	OD[
&ROOHFWRU(PLWWHU 9ROWD		,	
&ROOHFWRU%DVH 9ROWDJH			
(PLWWHU%DVH 9ROWDJH		,	
&ROOHFWRUEDVH &XWRII &X			9
%DVHHPLWWHU &XWRII &XUU			9
'& &XUUHQW *DLQ			
	)(	K	& \$ 9( 9
			& \$ 9( 9

&ROOHFWRU(PLWWHU 6DWXUDWL8 H&ZPLQ 0€~\$„4 Â'#

[Redacted line]

[Redacted line]

[Redacted line]

[Redacted area]



# PBSS4230T

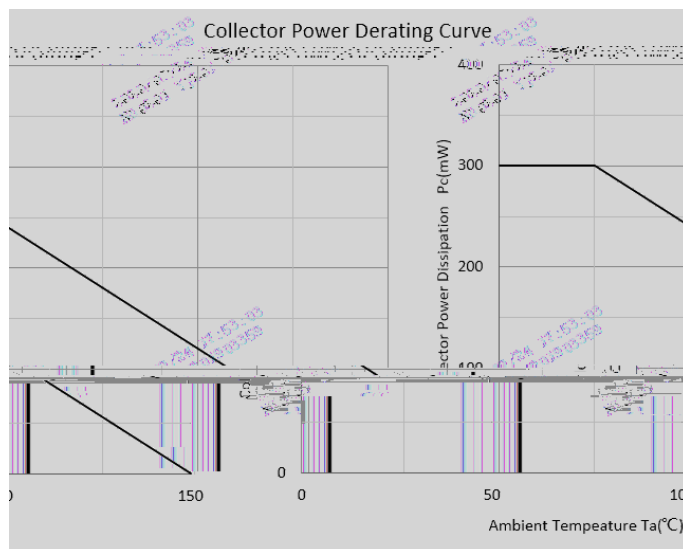
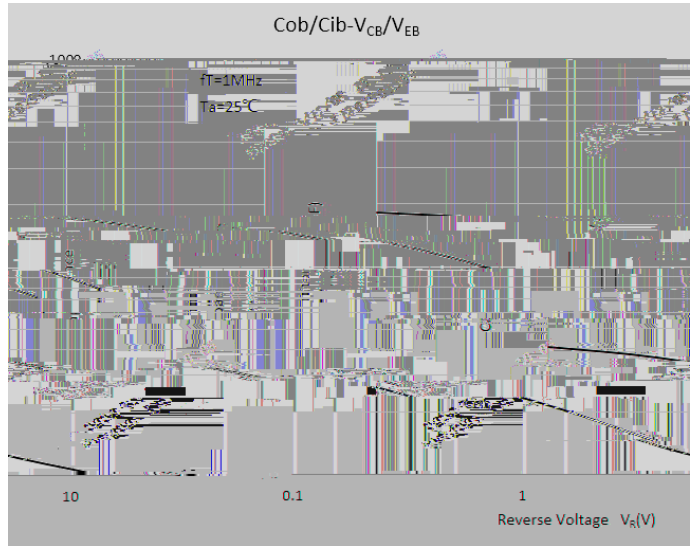
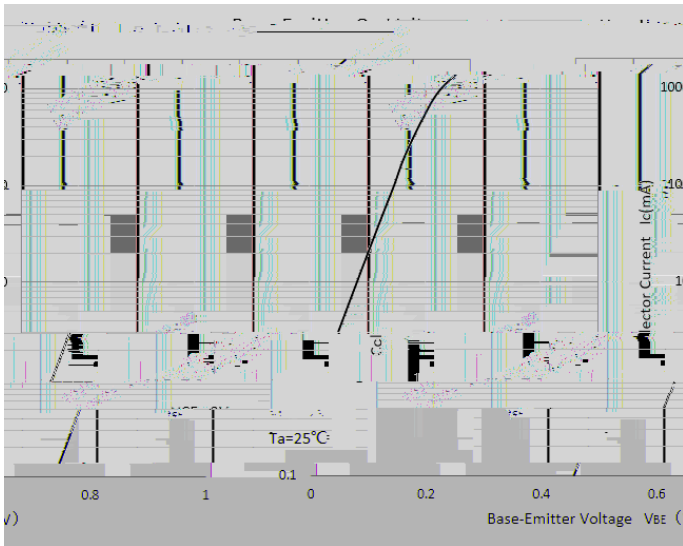
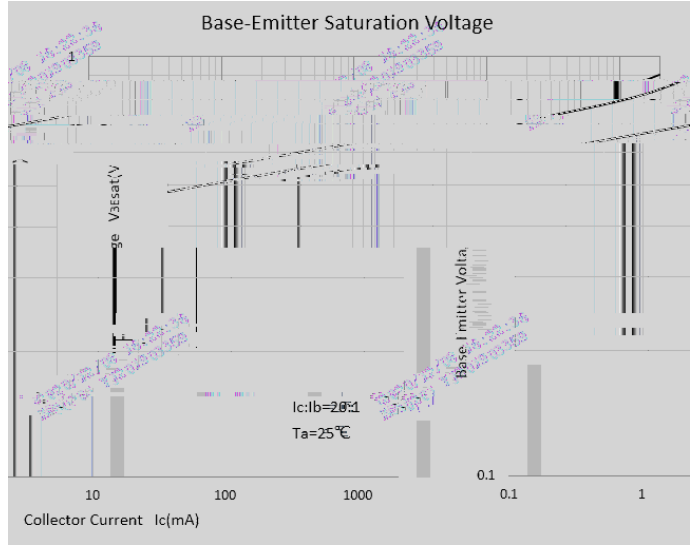
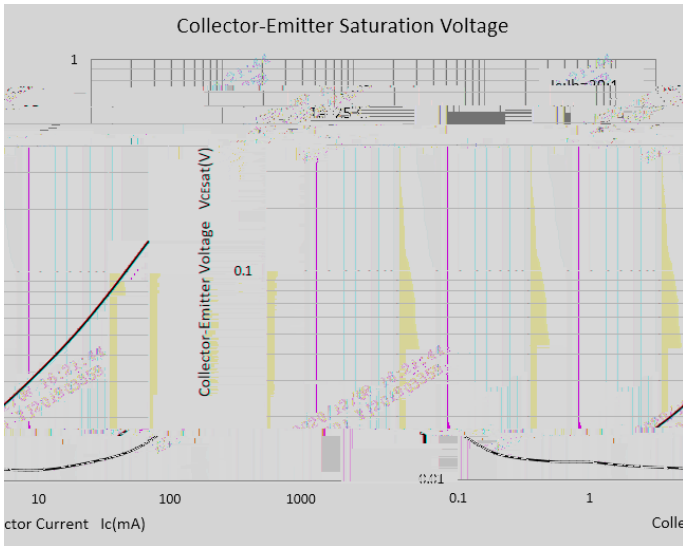



SOT23 Package Outline Dimensions

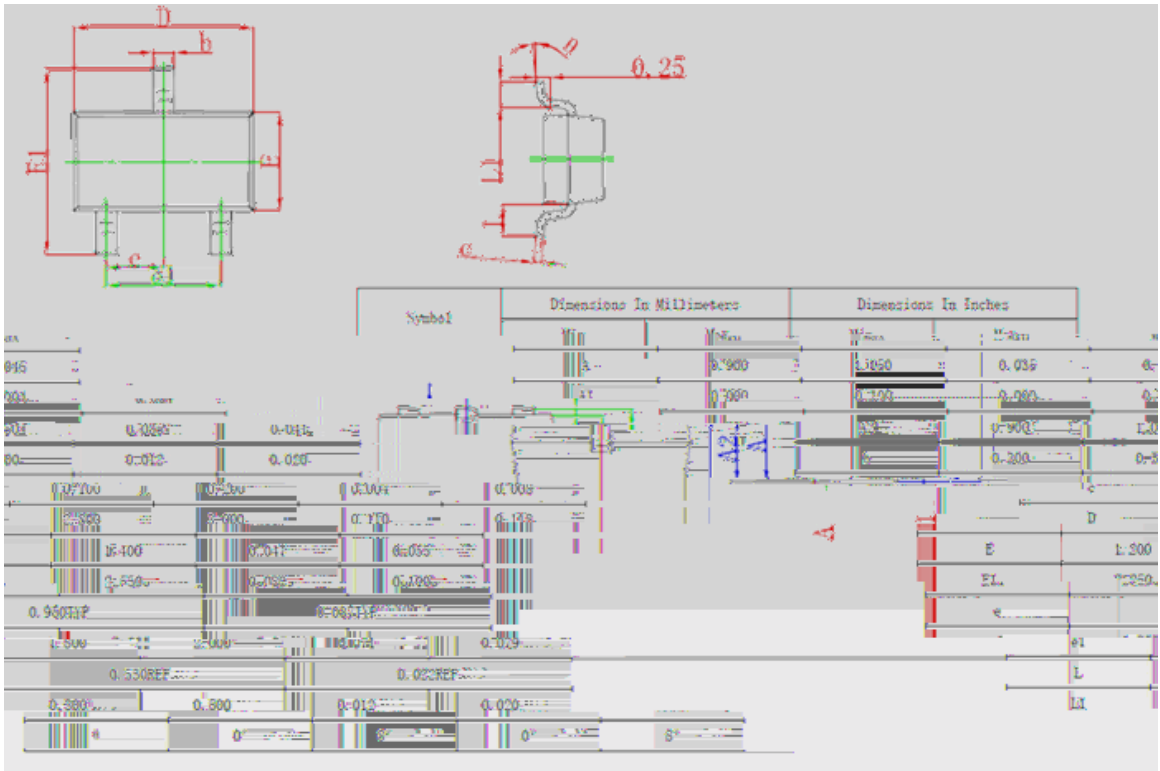

SOT23 Soldering Footprint

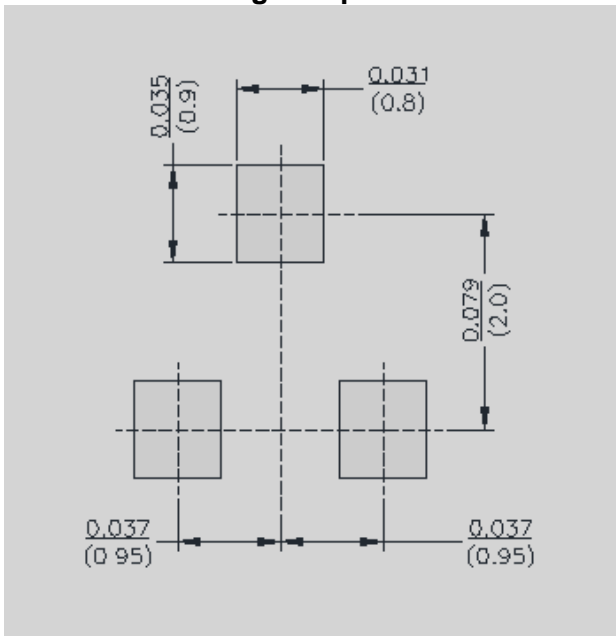



Disclaimer

V@^ ã-[!{æcá[] ]!^•^}c^á ã) c@ã• á[&~ {^}c ã• -[! !^•^!^} &^ []|^É Yæ}\* :@ [ ~ Yæ} \*há^ Ò|^&c![]]i& V^&@} [[|^ \*^ Ô[ÉÉ ŠcáÉ !^•^!ç^• c@^  
há\*^c c [ {æ\^ &Ö\*^• , ñc@ [ ~c } [c ñ&^ -[! c@^ •]^&ã-ã&cá[] [- c@^ ]! [á~&c• áã• ]|æ^á @^!^ã T c [ ã { ]! [ç^ !^ã àã| c^~ } &ã^ã• } T [ [! [c@^!•^É

V@^ ]! [á~&c |ã•c^á @^!^ã] ã• á^•ã\* } Ó^á c [ à^ ~•^á , ñc@ [ !ãã]æ!^|^&c![]]i& ^~ã { ^}c [ ! á^çã&^É æ}á } [c á^•ã\*] Ç^á c [ à^ ~•^á ç@  
^~ã] { ^}c [ ! á^çã&^• , @Óã&@ !^~ã!^ @ã\*^@ |^ç^! [- !|^ããã|ã^ æ} c@^ { æ-~ } &cá[] [- , ñc@ , [ ~|^ã áã!^&c|^} áæ} \*^! @~ { æ} |ã-^ ç• ~&@ æ•  
{ ^ãã&æ| ã} •c!~ { ^}c•É c!æ} • ] [ !cæcá[] ]  
^~ã] { ^}c!^É &|^æ!|^æ&c![] æ^ [ D•] Çã&^ ÇE -~^! { &cá[] }  
á^çã&^• D T Yæ} \*há^ [ T æ]^ [ T [ ñc• á^& -É æ•• { ^ããã [ !|^ããã] •ã æ}^ á Çæ { æ\*Ç^• !^•~|ç} \* -! [ { •~&@ ã { ]! [ ]^+^  
[- •æ|^É

V@ã• ] ~ à|ã&cá[] } •~ ]^!•^á^• !